

Instruction Manual

High Power, High Speed, High Current
Laser Diode Driver/Power Supply

Models: LD-XXXXQCW



This manual contains Operating, Safety, and
Maintenance information and subjects to change without notice.



3735 Coffey Ln, Santa Rosa, CA 95403, Phone:(707) 575 8821, Fax:(707) 526 3905, Email:info@LicEngine.com

Lic engineering
3735 Coffey Lane
Santa Rosa, CA 95403 USA
Phone: (707) 575 8821
Email: info@LicEngine.com

2010 Rev.2.2

TABLE OF CONTENTS

SECTION	Pages
1. DESCRIPTION	
1.1 General -----	2
1.2 Description -----	2
1.3 Specification -----	5
1.4 Front Panel & Control Signals-----	8
1.5 Explanation of Front Panel & Control Signals -----	9
1.6 Back Panel -----	14
1.7 Monitor Scope Specification -----	16
2. INSTALLATION	
2.1 General -----	21
2.2 Inspection -----	21
2.3 Output Connection -----	21
2.4 Block Diagram-----	23
2.5 AC Line -----	24
3. OPERATION	
3.1 Preparation -----	25
3.1.1 Current Droop -----	25
3.1.2 Average Power and Pulse setting -----	25
3.1.3 Rise Time, Load Impedance, & Output Voltage ----	26
4. MAINTENANCE	
4.1 General -----	32
4.2 Caution -----	32
4.3 Trouble Shooting -----	32
5. WARRANTY	
5.1 Warranty -----	33
5.2 Return of the unit -----	33

1.1

GENERAL

High Power, High Speed, High Current Laser Diode Driver/Power Supply, LD-XXXXQCW are designed to drive a laser diode in CW, QCW (Quasi Continuous Wave), and Normal Pulse mode. LD-XXXXQCW has achieved QCW high power up to **1KV/1KA/1MW**, and a **fastest rise time of 50-100 ns, and high peak current up to 1KA** in QCW/Pulse mode. Special made stripline enables the distance from the unit to a laser diode 1m (standard), or 2m (optional) keeping the rise time of 50-100ns & the minimum pulse width of 200ns. High Power QCW laser diode driver LD-XXXXQCW contains a digital monitor scope (the rise time of 3.5ns, or 7ns) and a high speed current sensing device to watch the real load current as well as a drive signal at the same time so that user can monitor the real operating condition without using any extra instruments and devices.

1.2

DESCRIPTION

The high current/high power laser diode drivers LD-XXXX/QCW uses a high frequency **zero-current switching** to minimize a switching loss and achieve a high conversion efficiency in a small body (up to **5KW CW Power with air cooled, and 25KW with water cooled**). This zero-current switching technology has been used for Lic's CO2 laser power supply for long time. This soft switching technology is also used for our new development of the 6KW true sine wave inverter. Refer to: <http://www.licengine.com/products/LSP-120.html>

Complete protection circuits:

Unit contains the complete protection circuits to protect the unit against any possible damages. These circuit detect total 7 faults: 1) Over Current of output switch (**100ns response time**), 2) Over Current of internal power supply, 3) Over Temperature of the unit, 4) Over Load caused by a wrong pulse setting, 5) Pulse Width Protection for external pulse setting, 6) Pulse Frequency Protection for external pulse setting, 7) Interlock for an additional safety.

50 ohm BNC output is used to monitor the real time output current accurately. The attenuation ratio is 5mV/A-10mV/A depends on the specification selected.

Accurate, high speed, and high power current sense system:

The load current is sensed with an ultra small inductance and high power resistor that accuracy is **+/- 1%** and its inductance is far below **0.1nH**. To minimize the inductance, we use the same technology that has been used for our LSP-series high current sensing technology for long time.

Capacitor charging power supply:

LD-XXXX/QCW high power pulsed laser diode driver uses a built-in a *High efficient Capacitor Charging Power Supply*. In QCW mode, the output current is supplied through a huge capacitor bank where the necessary output energy is stored. This capacitor bank is charged and discharged at the speed of switching frequency of the capacitor charging power supply during Output enabled SW. is activated. This means the load impedance is changed from **short circuit to infinite impedance** in a short time from the capacitor charging power supply point of view.

If this type of capacitor charging power supply is not used, there maybe many problems arises.

Refer to 1.8 CAPACITOR CHARGING POWER SUPPLY for detail.
Lic engineering has a long experience and accumulated technologies in this capacitor charging power supplies that have been used for various lasers systems such as Super Pulse CO2 lasers, and Yag lasers.

Series resonant topology:

Since the first product was developed in early 1980s, Lic's switch-mode laser power supply has used the "series resonant topology", which make a switching current "**sinusoidal**", or "**zero-current switching**" to make the switching loss minimal and is able to push a very high current into the secondary circuit in very short time. This sinusoidal switching, or zero-current switching technology makes Lic's products **high efficient, compact**, and **reliable power supply**.

Double switching technology:

Combined with this double switching technology LD-XXXXQCW enables a high power/accurate output voltage tracking and a fast output switching at the same time. User can changes, or sets the output voltage/current freely regardless the load current is flowing, or not flowing, and our accurate tracking mechanism tracks and set the exact output voltage/current that user desires. Refer to 1.8 CAPACITOR CHARGING POWER SUPPLY for detail.

The high-speed semiconductor switches located in the output pass controls the pulse width from 200ns with the fastest rise time of 50-100ns (optimum condition) and pulse repetition rate up to the 50KHz.

Super Pulse & LSP:

High power QCW laser diode driver LD- XXXX/QCW can generate a high peak pulsed current called Super Pulse and LSP in Enhanced Pulse mode (optional). Lic engineering is **the original develop company** for the Super Pulse in early 1980's for medical CO2 laser applications.

Refer to Manual: <http://www.licengine.com/support/pdf/ManualA.pdf>

Using the same pulse switching technologies used for these Super Pulse CO2 laser products, Lic engineering has achieved the Super Pulse capability in Laser Diode applications too. (Above 500A peak, the pulse is called **LSP; Lic Super Pulse**. For the LSP operation, our other model of LSP-series driver is available for the peak current up to **5KA**.)

Refer to Manual: <http://www.licengine.com/support/pdf/Manual-LSP1B.pdf>

Digital monitor scope:

Digital monitor scope is equipped in the front panel to watch the real load current as well as a drive signal at the same time. Combined with a built in accurate current monitor output, user can monitor the real operating condition without using any other device such as a high speed, high power current sensing resistor, and instruments such as an extra oscilloscope.

Refer to 1.5.1 Digital Monitor Scope for detail.

1.3 SPECIFICATIONS OF LD-XXXXQCW

1.3.1 AC INPUT

100V (Less than 1.0KW CW Power), 120V (Less than 1.0KW CW Power), 208V, 220V, 230V, 240V: +/- 10%, Single and Three phase, 47-63Hz.

Note: Other voltage such as 380V, 480V ranges are also available by request.

1.3.2 OUTPUT POWER

From 500W to 5KW Continuously in CW mode: LD-XXXXQCW in CW mode
Up to 1MW in QCW/Pulse mode: LD-XXXXQCW in QCW mode

**LD-XXXXQCW can be the maximum CW power up to 25KW.
This unit is water cooled, so the dimension is the same as 5KW
Air cooled version: 19.0" (W, 17" body only) x 15.0"(D) x 10.50" (H)
Please contact to factory for detail.**

1.3.3 MAX. OUTPUT VOLTAGE

Up to 1KV (User selectable from 50V to 1KV)

1.3.4. OUTPUT CURRENT

Up to 1KA in QCW mode (User selectable).

1.3.5 OUTPUT POLARITY

Positive (Standard).

1.3.6 OUTPUT RISE TIME

3 User Selectable Positions:

Slow/Mid./Fast

Fastest rise time can be less than 50-100 nano-seconds (depends on output condition) at a Fast Rise Time position.

The slowest rise time is 1us at Slow Rise Time position.

Note: The rise time could be increased if the output voltage is very low and the output current is higher above 500A.

Refer to 2.3 Output Stripline Connection and 3.1.2 Rise Time & Load Impedance for detail.

1.3.7 MAXIMUM & MINIMUM PULSE REPETATION RATE

Minimum: Single Shot

Maximum:

In Normal Pulse & Super Pulse: 50KHz

Adjustable Range: 500-1000

Note: In QCW mode, the pulse rate is limited by the average power and the current droop specified.

Refer to 3.1.1 Average Power and Pulse Setting for detail.

1.3.8 MAXIMUM & MINIMUM PULSE WIDTH

Minimum: 200 nano seconds (External pulse)
500ns (Internal Clock)

Maximum: Up to 10ms in QCW mode,
(Depends on the Current Droop required and Output Voltage), or CW in CW mode.

Capacitor Bank Value: Refer to 3.1.0 Current Droop and 3.1.1 Average Power and Pulse Setting for detail.
Up to 0.5 farads.
Refer to the 3.1.0 Current Droop for detail.

Adjustable Range: 500-1000

Note1: In QCW mode, the maximum pulse width is limited by the average power and the current droop specified.

Note2: The minimum pulse width could be limited if the output voltage is very low and the output current is higher above 500A.

1.3.9 PULSE DUTY

5%-100%:

Including CW, CW chopping (normal pulse). In QCW mode, the pulse duty is usually less than 50% because the average power of the unit.

Note: The Pulse duty is limited by an average power that user decided at the order.

Refer to 3.1.1 Average Power and Pulse Setting.

1.3.10 LOW FREQUENCY RIPPLE CURRENT

Less than 1% at rated current

1.3.11 EFFICIENCY

Total system efficiency greater than 80% in most case

1.3.12 LINE or LOAD REGULATION

+/- 1% for 10% change

1.3.13 PROTECTION CIRCUIT

There are total of 7 fault reasons that the unit ceases the operation. When the protection circuit detects those fault conditions, the unit shuts off instantaneously indicating with FAULT light.

Over Current Protection (1) for internal power supply:

Protects the internal power supply against (1) direct or indirect output short condition, (2) Any electrical disturbances induced by external or internal noises, (3) Overload caused from improper load, or pulse setting.

Over Current Protection (2) for output Switch:

The protection circuit for the output switch **activates in 100ns**. This response time is required to protect the switch against huge output power (the maximum peak pulse power reaches to 1MW!!). The load current is however, several hundred ns to several us delay time after the protection circuit is activated.

Over temperature protection:

Detects a base temperature on which main switching devices and other power semiconductors are mounted. When the base temperature reaches to setting level, the protection circuit activates and the unit ceases the operation.

Over load protection:

LD-XXXXQCW adjusts its average power automatically when pulse setting changes, and stays always within the pre-determined average power. When, however, the pulse setting exceeds the predetermined average power (by external pulse setting, for example), the over load protection activates to protect the internal power supply against an over load condition. This over load is calculated as a product of pulse width and pulse frequency.

With internal pulse mode, if user set a wrong pulse condition accidentally that exceeds the predetermined average power, the pulse rate is automatically adjusted to meet within the average power.

Pulse Width Protection:

When setting pulse width, or an external pulse setting exceeds a predetermined value, this protection circuit activates.

Pulse Frequency Protection:

When setting pulse frequency, or an external pulse setting exceeds a predetermined value, this protection circuit activates.

Interlock Input:

This is an additional safety feature. Unless this input is closed, the unit keeps fault condition.

This input can be used as a remote switch as well and the cable length can be several meters from the unit. This input is isolated with an optical isolator.

Note:

To restart the unit from the fault condition, use RESET signal. Refer to RESET signal at SECTION 1.4.4 for detail.

1.3.15 OPERATING TEMPERATURE

Ambient temperature: +10 to 40C

1.3.16 OUTPUT CONNECTORS

Main Output: AMP.7TWC8W8SMP3V4R

1.3.17 CURRENT MONITOR

CW/QCW/Normal pulse: Accuracy of +/-1%, Response Time of 100-200ns, 5mV/A-10mV/A, BNC 50 Ohm (Oscilloscope side must be terminated with a 50ohm to receive a right waveform).

1.3.17 EXTERNAL PULSE INPUT

BNC 1K Ohm impedance

1.3.19 DIMENSIONS (WxDxH inch)

Up to 2KW CW (Air cooled):	19.0" (W, 17" body only) x 13.0"(D) x 7.0" (H)
Up to 5KW CW (Air cooled):	19.0" (W, 17" body only) x 15.0"(D) x 10.5" (H) 10.50"(H) (Oscilloscope must be terminated with a 50ohm to receive a right waveform).
Up to 25KW CW (Water cooled):	19.0" (W, 17" body only) x 15.0"(D) x 10.50" (H)

1.4.20 WEIGHT (Lb.)

Up to 2KW CW:	22 lb
Up to 5KW CW:	33 lb
Up to 25KW CW:	55 lb (water cooled)

1.4 FRONT PANEL & SIGNALS



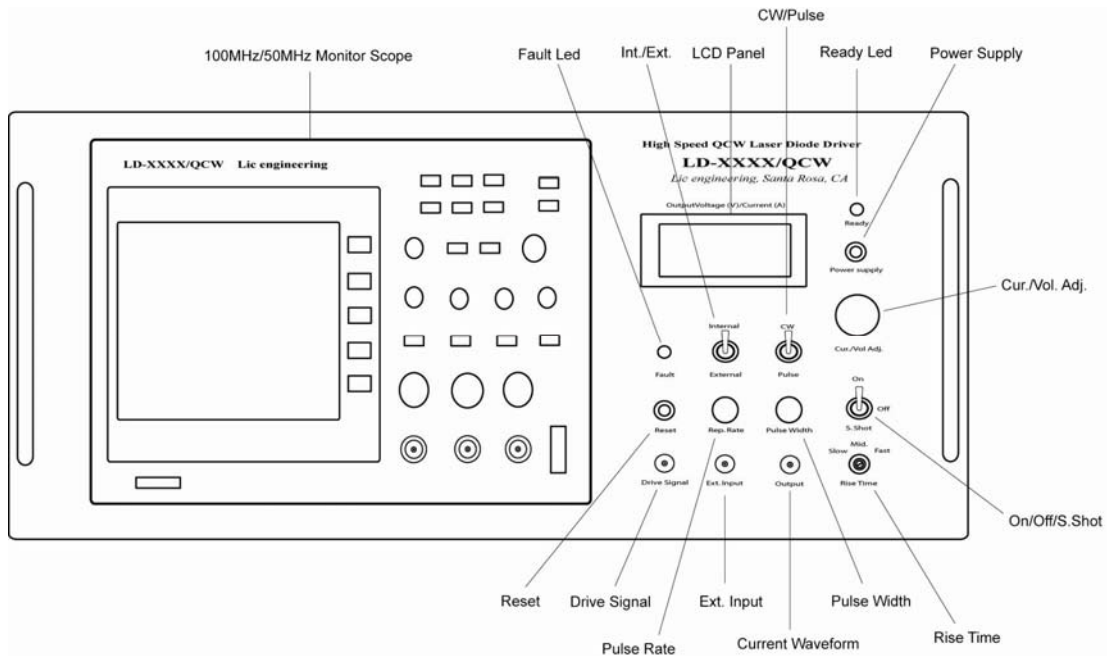

Front Panel of LD-XXXXQCW

1.5 EXPLANATION OF FRONT PANEL & SIGNALS

1.5.1 Digital Monitor Scope

Digital monitor scope is equipped in the front panel to watch the real load current as well as a drive signal at the same time. Combined with a built in accurate current monitor output, user can monitor the real operating condition without using any extra oscilloscope. This is very important for user:

1). User does not need to prepare A) expensive high speed current sensing device and B) oscilloscope.

2). This is also space saving and handy way for user's daily works.

User can select the vertical bandwidth of the monitor from 50MHz and 100MHz of which rise time is 3.5 ns and 7 ns respectively.

For the detail specification, see the section of 1.7 MONITORSCOPE SPECIFICATION in this manual.

1.5.2 Ready indicator (Yellow)

Indicates the unit is ready for operation.

1.5.3 Power Supply Sw.

When Power Supply SW. is pushed, the LCD panel power is supplied indicating the internal power supply for LD Driver is energizing. For safety purpose, this SW. is only turned on when the unit AC power is supplied. If the unit is accidentally powered off, and then on, the output is disabled even if a mechanical Output On/Off SW. is on position. To resume to the operation, push this SW again.

1.5.4 Output On/Off/S.Shot

Turning the output current on, off or single shot. This switch has three positions: Off (Center), On (Upper), and Momentary on (Down).
 With Internal Mode, the output timing is synchronized with internal pulse as illustrated bellow. With External mode, On switch and external pulse is not synchronized. To synchronize to external pulse, user can keep the Output Sw. at on position, and external pulse can be gated by user's control.
 There is certain delay time between drive signal (internal/external) and output current. This delay time is changed by a selection of Rise Time setting. See below for timing.

With External mode, Single Shot is disabled. To use a Single Shot, switch to Internal mode. Pulse width of single shot is determined by an internal pulse width setting.

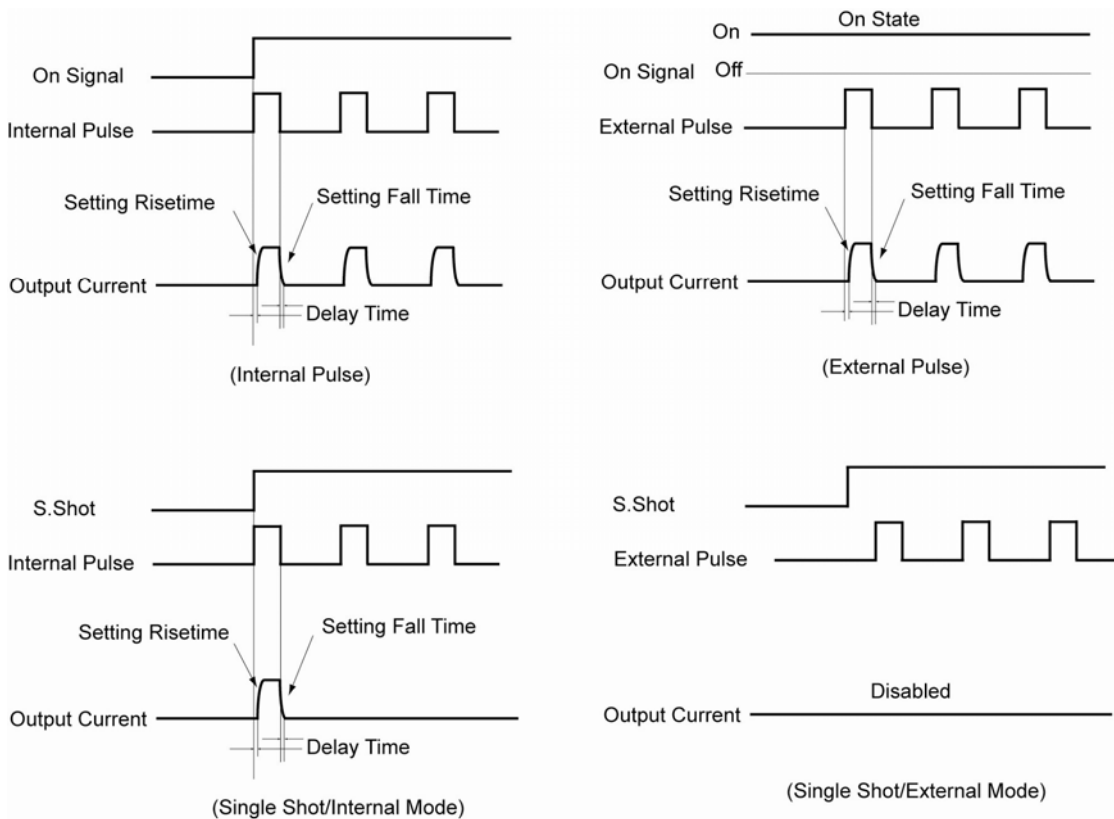

(Timing Chart of Internal Pulse/External Pulse and On/Off Switch.)

1.5.5 CW/Pulse

Switch the mode in CW, and Pulse.

For QCW unit, the mode is always in Pulse Mode regardless of the mode SW. position.

1.5.6 Internal/External

Switch the pulse input either an internal generator, or external pulse input. Do not change this SW. while the unit is running.

1.5.7 Fault indicator(Red)

Indicates the unit is in fault condition. There are total 7 fault reasons and those are:

- 1) Over Current of output switch
- 2) Over Current of internal power supply
- 3) Over Temperature of the unit
- 4) Over Load caused by a wrong pulse setting
- 5) Pulse Width Protection for external pulse setting
- 6) Pulse Frequency Protection for external pulse setting
- 7) Interlock for an additional safety

If unit detects any of those fault conditions, it ceases the operation and Fault indicator is lit.

See protection circuit section of 1.3.13 in this manual for detail.

Note:

To restart the power supply from the fault condition, use RESET signal. Refer to RESET signal at SECTION 1.4.4 for detail.

1.5.8 Current Monitor

50 ohm BNC output is used to monitor the real time output current. The attenuation ratio is 5mV/A-10mV/A depends on the specification selected. The load current is sensed with an ultra small inductance and high power resistor of which accuracy is $\pm 1\%$ and its inductance is far below **0.1nH**. To minimize the inductance, we use the same technology that has been used for our LSP-series high current sensing technology for long time.

Note *): The oscilloscope input have to be terminated with a 50 ohm to receive a correct waveform of the current.

1.5.9 Drive Signal Output

This is the output signal to activate/deactivate the output switch. With this signal user can synchronize the LD current gate time with user's external devices.

1.5.10 External Pulse Input

External pulse condition should not exceed the pulse set that is specified when the unit is ordered. If the pulse set exceeds the predetermined values, the unit ceases the operation indicating Fault condition. This is activated by Pulse Frequency Protection, Pulse Width Protection, and Over Load Protection.

Interface condition is TTL/CMOS, 5V/1Kohm.

1.5.11 Reset

Push this SW to recover to a normal operating condition after the fault reason is removed.

1.5.12 Pulse Rate Adj.

The pulse rate of the internal clock is adjusted by this knob. The minimum/maximum rate is limited to the pulse rate when the unit is ordered. The knob is a 10 turn potentiometer so that user can make a fine adjustment.

1.5.13 Pulse Width Adj.

The pulse width of the internal clock is adjusted by this knob. The minimum/maximum pulse width of the internal clock is limited to the value when the unit is ordered. The knob is a 10 turn potentiometer so that user can make a fine adjustment.

1.5.14 Cur./Vol. Adj.

Output current is adjusted by this knob. This knob is a 10 turn volume so that user can make a fine adjustment by watching the LCD panel as well as the monitor scope. As this knob moves, the internal precise tracking mechanism automatically adjusts the setting voltage regardless the LD current is flowing, or not (real time tracking system). With Lic's double switching technology, the setting voltage and actual LD current are quickly and accurately adjusted.

1.5.15 LCD Panel

LCD monitor to indicate the 3-1/2 digits output current/voltage value. This display indicates a real load current, or output voltage but not a setting current/voltage.

If Output SW. is not on position and in case display is voltage , of cause the display shows the setting voltage.

1.5.16 Rise Time Selection

Rise time can be selected at three positions:

Slow: around 500ns to 1us

Mid.: around 200ns to 500ns

Fast: around 50-100ns to 200ns

The exact value differs by 1) Output voltage ordered, 2) Load current, and 3) Load resistance. As a normal rule, when the output voltage is low, load current is high, or the load resistance is low, the rise time becomes slow. Refer to 3.1.3 Rise time and Load impedance, Output Voltage, and the following sample pictures.

Do not change this SW. while the unit is running.

1.5.17 Sample waveforms for Rise time

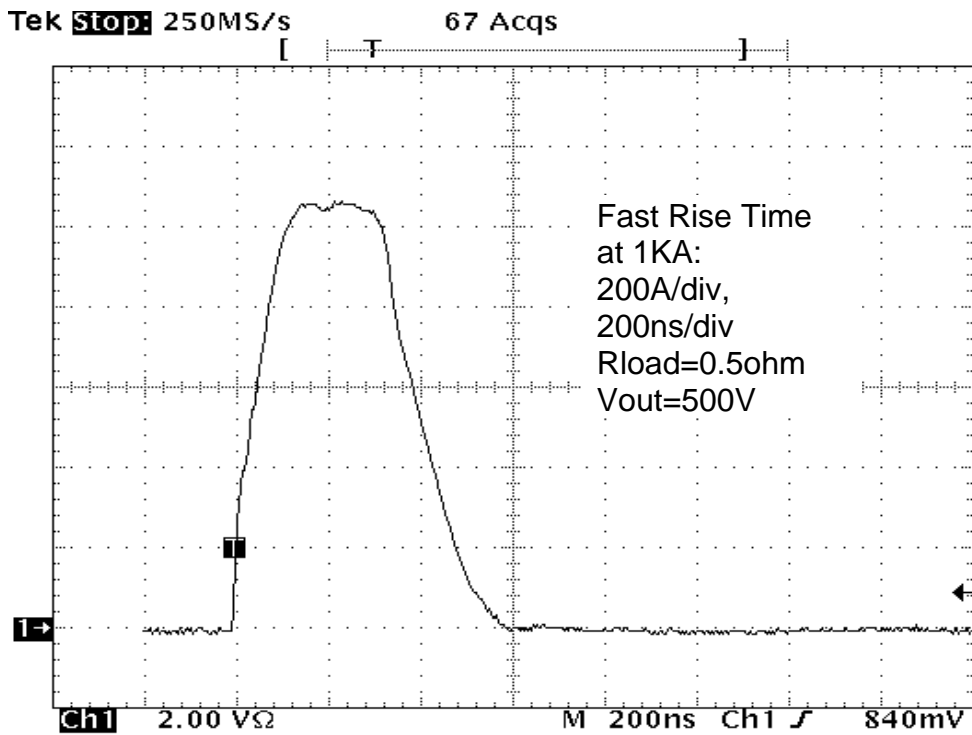
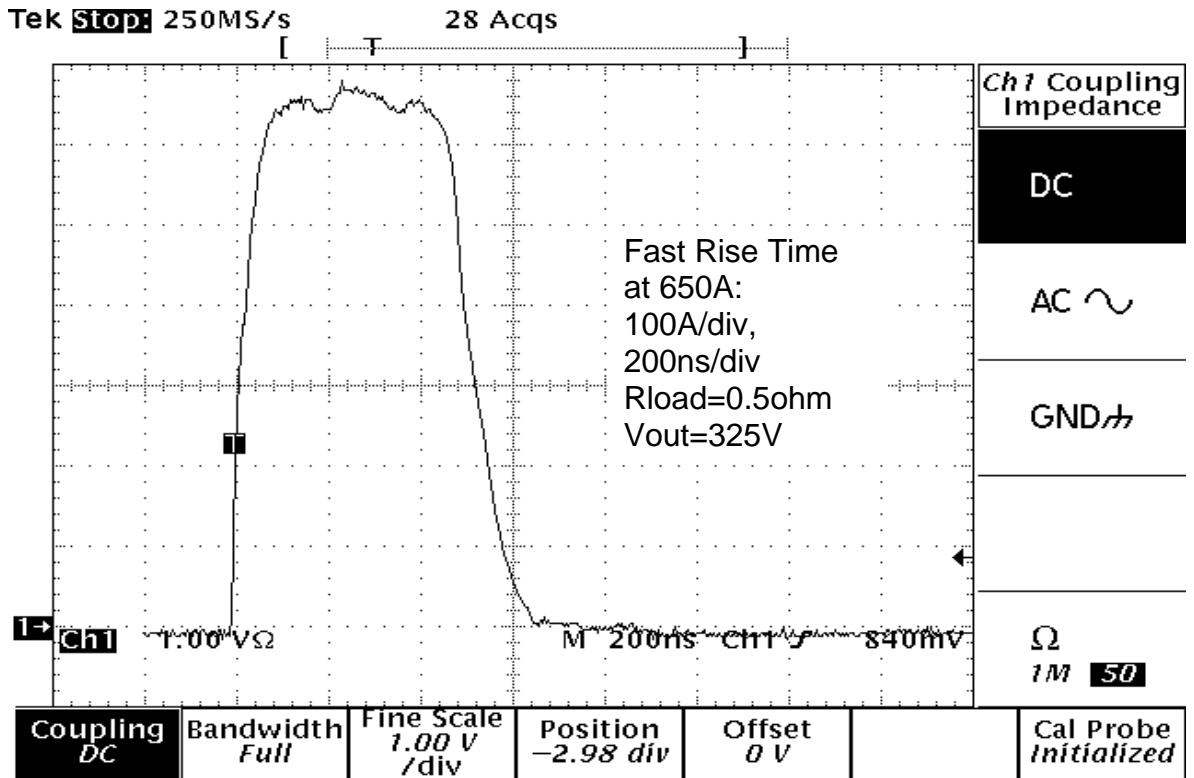

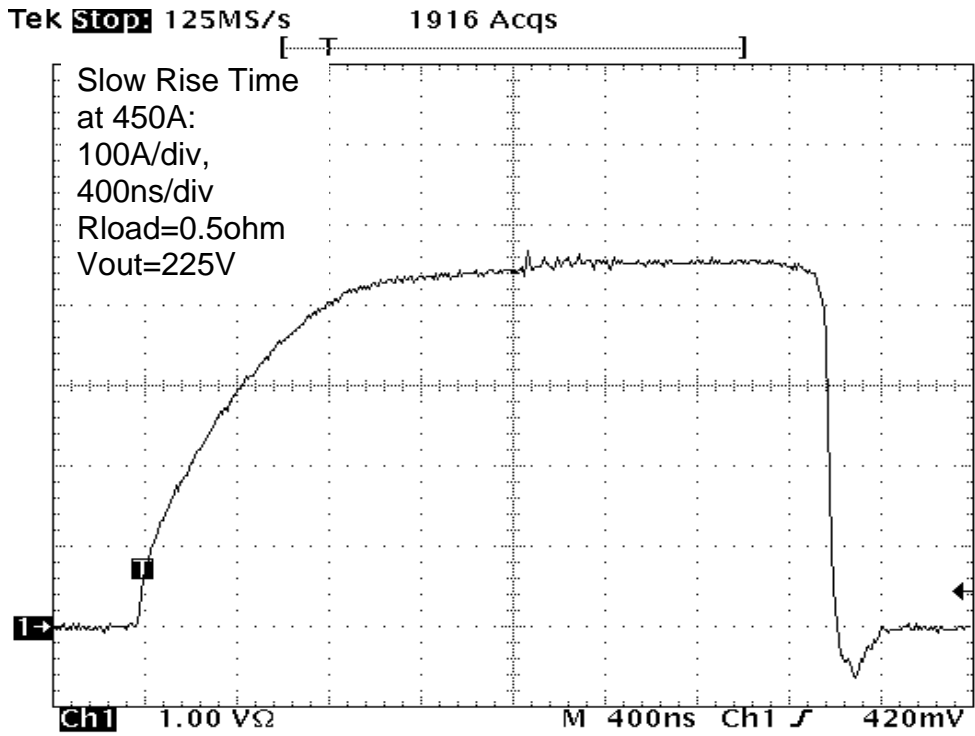

1.6 Back Panel

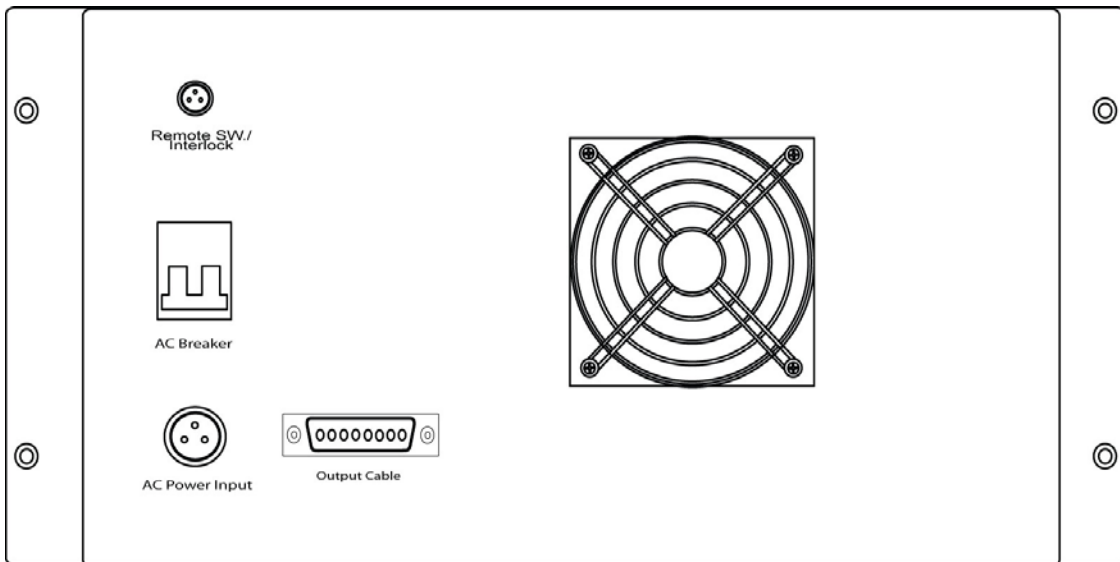

1.6.1 Cooling fan

Fan speed is controlled by internal device temperature. As the device temperature increases, the fan speed increases.

1.6.2 Interlock/Remote SW

This is an additional safety input. To activate the unit, this input must be closed. This input can be used as a remote switch as well and the cable length can be several meters from the unit. This input is isolated with an optical isolator.

1.6.3 AC Circuit Breaker

This is used as a power switch as well as an emergency cut off switch. To use the unit, first turn this breaker on. If by some reason the internal safety features do not work, this circuit breaker shut off the AC power from a power line.

1.6.4 Output Connector

To connect a load to the unit, a special made transmission line is used. This is called stripline designed to carry a high current without destroying the fast rise time pulse shape. One side of the strip line is just open to the load to connect by soldering/screws.

The other side of the stripline is terminated with AMP.7TWC8W8SMP3V4R female connector.

See 2.3 section for detail.

1.7 Monitor Scope Specification

Specifications

Acquisition			
Sampling Modes	Real-Time	Equivalent	
Sampling Rate	1GSa/s, 200MSa/s ^[1]	XXX1	XXX2
		25GSa/s	10GSa/s
Averages	N time acquisitions, all channels simultaneously, N is selectable from 2, 4, 8, 16, 32, 64, 128 and 256.		

Inputs	
Input Coupling	DC, AC, GND
Input Impedance	1MΩ±2%, in parallel with 15pF±3pF
Probe Attenuation Factors	1X, 5X, 10X, 50X, 100X, 500X,1000X
Maximum Input Voltage	400V (DC+AC Peak, 1MΩ input impedance)
	40V (DC+AC Peak) ^[1]
Time delay between channel (typical)	500ps

Horizontal				
Sample Rate Range	Real-Time: 13.65Sa/s-1GSa/s			
	Equivalent: 13.65Sa/s-25GSa/s			
Waveform interpolation	Sin(x)/x			
Record Length	Channel Mode	Sample rate	Record Length (normal)	Record Length (long record)
	Single channel	1GSa/s	16Kpts	N.A.
	Single channel	500MSa/s Or lower	16 Kpts	1Mpts
	Double channel	500MSa/s Or lower	8 Kpts	512Kpts
Scan speed Range (Sec/div)	2ns/div~50s/div, XXX1 5ns/div~50s/div, XXX2 1-2-5 Sequence			
Sample Rate and Delay Time	±50ppm (over any 1ms time interval)			

Accuracy	
Delta Time Measurement	Single-shot: $\pm(1 \text{ sample interval} + 50\text{ppm} \times \text{reading} + 0.6 \text{ ns})$
Accuracy (Full Bandwidth)	>16 averages: $\pm(1\text{sample interval} + 50\text{ppm} \times \text{reading} + 0.4 \text{ ns})$

Vertical	
A/D converter	8-bit resolution, each channel samples simultaneously ^[2]
Volts/div Range	2mV/div~10V/div at input BNC
Maximum Input	Analog channel maximum input voltage CAT I 300Vrms, 1000Vpk ; instantaneous voltage 1000Vpk CAT II 100Vrms, 1000Vpk RP2200 10:1 : CAT II 300Vrms RP3200 10:1 : CAT II 300Vrms RP3300 10:1 : CAT II 300Vrms
Offset Range	$\pm 40\text{V}(200\text{mV}-10\text{V}), \pm 2\text{V}(2\text{mV}-100\text{mV})$
Analog Bandwidth	100MHz (XXX1) 50MHz (XXX2)
Single-shot Bandwidth	80MHz (XXX1) 50MHz (XXX2)
Selectable Analog Bandwidth Limit (typical)	20MHz
Lower Frequency Limit (AC -3dB)	$\leq 5\text{Hz}$ (at input BNC)
Rise Time at BNC, typical	<3.5ns, <7ns, On (100M, 50M) respectively
DC Gain Accuracy	2mV/div-5mV/div: $\pm 4\%$ (Sample or Average acquisition mode) 10mV/div-10V/div: $\pm 3\%$ (Sample or Average acquisition mode)
DC Measurement Accuracy, Average Acquisition Mode	Average of ≥ 16 Waveforms with vertical position at zero: $\pm(\text{DC Gain Accuracy} \times \text{reading} + 0.1\text{div} + 1\text{mV})$ Average of ≥ 16 Waveforms with vertical position not at zero: $\pm[\text{DC Gain Accuracy} \times (\text{reading} + \text{vertical position}) + (1\% \text{ of vertical position}) + 0.2\text{div}]$ Add 2mV for settings from 2mV/div to 200 mV/div

	Add 50mV for settings from >200mV/div to 10V/div
Delta Volts Measurement Accuracy (Average Acquisition Mode)	Delta Volts between any two averages of 16 waveforms acquired under same setup and ambient conditions: $\pm(\text{DC Gain Accuracy} \times \text{reading} + 0.05 \text{ div})$

Trigger		
Trigger Sensitivity	0.1div~1.0div (adjustable)	
Trigger Level Range	Internal	± 5 divisions from center of screen
	EXT	$\pm 1.2\text{V}$
Trigger Level Accuracy (typical) applicable for the signal of rising and falling time $\geq 20\text{ns}$	Internal	$\pm(0.3\text{div} \times \text{V/div})(\pm 4$ divisions from center of screen)
	EXT	$\pm(6\%$ of setting + 200 mV)
Trigger Offset	Normal mode: pre-trigger (262144/ sampling rate), delayed trigger 1s	
	Slow Scan mode: pre-trigger 6div, delayed trigger 6div	
Trigger Holdoff range	100ns~1.5s	
Set Level to 50% (Typical)	Input signal frequency $\geq 50\text{Hz}$	
Edge Trigger		
Edge trigger slope	Rising, Falling, Rising + Falling	
Pulse Trigger		
Trigger condition	$(>, <, =)$ Positive pulse, $(>, <, =)$ negative pulse	
Pulse Width range	20ns ~10s	
Video Trigger		
Video standard & line frequency	Support standard NTSC, PAL and SECAM broadcast systems. Line number range: 1~525 (NTSC) and 1~625 (PAL/SECAM)	
Slope Trigger		
Trigger condition	$(>, <, =)$ Positive slope, $(>, <, =)$ negative slope	
Time setting	20ns~10s	
Alternate Trigger		
Trigger on CH1	Edge, Pulse, Video, Slope	
Trigger on CH2	Edge, Pulse, Video, Slope	
Pattern Trigger ^[1]		

Trigger mode	D0~D15 select H, L, X, f , \bar{f}
Duration Trigger ^[1]	
Trigger Type	D0~D15 select H, L, X
Qualifier	>, <, =
Time setup	20ns~10s

Measurements		
Cursor	Manual	Voltage difference between cursors (ΔV) Time difference between cursors (ΔT) Reciprocal of ΔT in Hertz ($1/\Delta T$)
	Track	Voltage value for Y-axis waveform Time value for X-axis waveform
	Auto	Cursors are visible for Automatic Measurement
Auto Measure	Vpp, Vamp, Vmax, Vmin, Vtop, Vbase, Vavg, Vrms, Overshoot, Preshoot, Freq, Period, Rise Time, Fall Time, +Width, -Width, +Duty, -Duty, Delay1→2 f , Delay1→2 \bar{f}	

[1] For XXX1 Series;

[2] When sampling is 1GSa/s, only single channel can be used.

1.8 CAPACITOR CHARGING POWER SUPPLY

High Power Laser Driver, LD-XXXXQCW contains a high efficient and powerful capacitor charging power supply. This type of power supply is designed to charge a capacitor load efficiently. It works at full power condition regardless the load is shorted, heavy or light. If a normal DC power supply is used for this purpose, the heaviest load is at the shorted condition and the lightest load is at the end of charging process, so the charging process is very inefficient.

There are many drawbacks to use the regular DC power supply for this application:

- 1). DC power supply may be tripped by an over current fault.
- 2). There maybe no feedback loop formed between the charging power supply and the capacitor bank, so the accurate and real time setting/adjustment is difficult.
- 3). It takes a long time to charge up because the charging process is very inefficient.
- 4). For these reasons, the regular DC power is typically required 2 times bigger power than the average power required for the load.
- 5). It may need an extra series resistor to avoid an over load condition and this causes a fair amount of heating loss.

In LD-XXXXQCW unit, there is a feedback loop formed between the huge output capacitor bank and the capacitor charging power supply to set and regulate the output voltage/current accurately.

If user increases the output voltage/current and then decrease it at no load condition (Output SW. is deactivated/off position), or very light load, then the charged up voltage is difficult to decrease because the capacitor is so huge and mere bleeder resistor is not sufficient to discharge it in short time. It may take several minutes under certain condition.

To overcome this problem, we use the **double switching technology** that charging and discharging very efficiently. Combined with the precise tacking system, user can set/adjust the capacitor bank voltage freely regardless the output is in heavy load, or no load at all.

2.0 INSTALLATION

2.1 GENERAL

After unpacking, general inspection and preliminary checkout procedures should be performed to ensure that the unit is in proper working order. If it is determined that the unit has been damaged, the carrier should be notified immediately. Contact Lic directly:

Lic engineering
3735 Coffey Ln.
Santa Rosa, CA 95403 USA
Tel: (707) 575 8821
Fax: (707) 526 3905
email: info@LicEngine.com

2.2 INSPECTION

Check for damage incurred during shipment as follows:

1) Inspect unit case for cracking, bending, and other obvious signs of damage.

2.3 OUTPUT STRIPLINE CONNECTIONS

Connect the stripline to the load (Laser Diode) using a soldering iron, or screws.

The physical distance between the load and tip of the stripline must be as short as possible.

Do not use any extra wires to connect between the strip line and a Laser Diode.

USING SUCH EXTRA WIRES WILL INCREASE A RISE AND FALL TIME DRAMATICALLY.

PLEASE REFER TO LSP-XXXX-XX MANUAL FOR DETAIL:

[HTTP://WWW.LICENSE.COM/SUPPORT/PDF/MANUAL-LSP1B.PDF](http://www.licengine.com/support/pdf/manual-lsp1b.pdf)

Formula is $T_{rise-time} = L \cdot di / V_o$,

where V_o : the maximum output voltage of the unit, di : Current increment within the time of $T_{rise-time}$, L : Total inductance (LD-pin inductance plus internal lead wire inductance, plus external lead wire inductance).

Example 1):

500A load current, Total inductance=100nH, and Output voltage =50V, then, the fastest rise time T is only 1 us.

Example 2):

500A load current, Total inductance=100nH, Output Voltage =300V, then the fastest rise time will be: 170ns-200ns.

Refer to 3.1.3 RISE TIME, LOAD IMPEDANCE, AND OUTPUT VOLTAGE

THE FORWARDING VOLTAGE OF CONNECTED LD MUST BE CLOSE TO THE OUTPUT VOLTAGE SPECIFIED WHEN THE UNIT IS ORDERED. IF THE LD VOLTAGE IS MUCH LOWERED THAN THE VALUE SPECIFIED, THE RISE TIME OF OUTPUT CURRENT BECOMES SLOW. IN THIS CASE, THE SERIES RESISTOR CAN BE CONNECTED AS SHOWN IN THE FOLLOWING PICTURE. THIS SERIES RESISTORS SHOULD BE VERY LOW INDUCTANCE TYPE AND MUST SATISFIE THE EXPECTED PEAK CURRENT, VOLTAGE AND AVERAGE POWER.

Refer to 3.1.3 RISE TIME AND LOAD IMPEDANCE, OUTPUT VOLTAGE for detail.

Contact factory if user can not find such resistors. Lic has a wide range of non-inductive resistor of which power ranges from **5W (air cooled) to 5KW (water cooled)**.

To protect user's LD from a reverse current, it is good idea to use a protection diode connected in parallel with the LD as follows. The reverse current will increase when the load inductance is increased. Check with a current monitor waveform if the reverse current is within safe area.

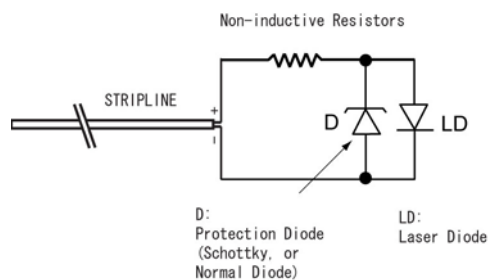

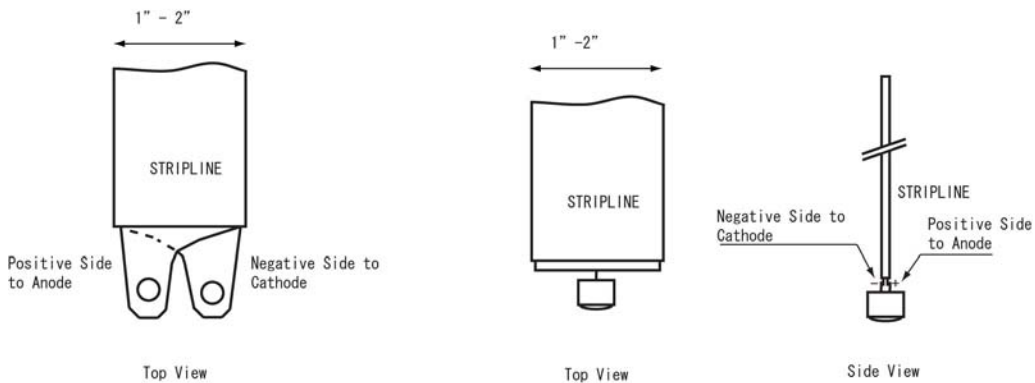

(1) For Screw Type Terminal

(2) For Pin Type Terminal

2.4 INTERLOCK CONNECTION

Connect Interlock connector to the unit. Make sure the end of wire is connected together (Shorted).

If Interlock input is not shorted, the unit becomes Fault condition.

This wire can be used as a remote switch to activate/deactivate the load current.

2.5 BLOCK DIAGRAM OF THE UNIT

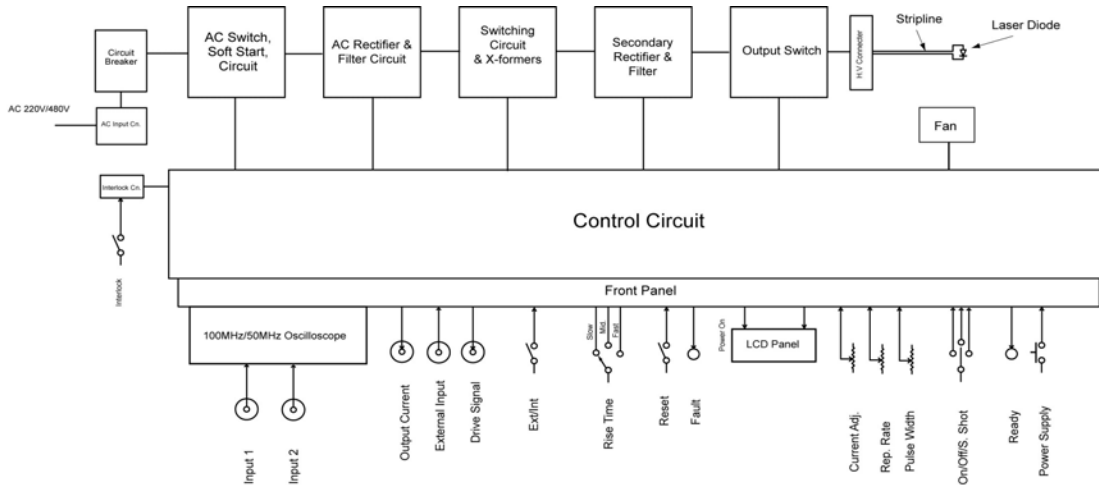

(Block Diagram)
LD-XXXX/QCW

2.6 AC LINE CONNECTION

Confirm AC GND (Earth GND) is connected to the power supply GND.

Confirm that AC line voltage is proper for the unit ordered, and AC power to the unit is still off. The standard center voltages are:

100/115/208/220, Single phase/three phase, +/- 10%

3.0 OPERATION

3.1 PREPARATION & PRECAUTION

3.1.1 CURRENT DROOP

In QCW mode, the output current decays by the time for the given pulse width. The percentage of this current deduction is decided by A). The value of the capacitor bank, B). Pulse width, and C). The load impedance.

The formula is $d = Pw \times 100 / C \times Z_d$ (%),
 where d = current droop (%), Pw = Pulse width (seconds), and Z_d = load impedance (ohm: LD voltage (V) / LD current (A))

Example 1):

LD current = 200A, LD voltage is 100V, $C = 0.25(F)$, $Pw = 5msec$,
 $d = 5 \times 10^{-3} \times 100 / 0.25 \times 100 / 200 = 4\%$

Example 2):

LD current = 500A, LD voltage is 50V, $C = 0.25(F)$, $Pw = 5msec$,
 $d = 5 \times 10^{-3} \times 100 / 0.25 \times 50 / 500 = 20\%$

LD-XXXX-XX has the maximum C in the capacitor bank of 0.5 (Farads).

To improve the current droop, there are several ways:

- 1). Select the biggest capacitor bank.
 Cons: The unit becomes expensive.
- 2). Decrease LD current, or Pulse Width.
 Cons: Pulse width/LD current is limited.
- 3). Connect a resistor in series with LD.
 Cons: Has to prepare the special resistor and the power loss at the series resistor.

3.1.2 AVERAGE POWER AND PULSE SETTING.

In QCW mode, both Pulse Width and Pulse Rate are limited by an average power of the unit.

Assume the ordered unit is 5KW average power, the maximum pulse width is 5ms, LD voltage is 100V, and the maximum load current is 1KA, then the maximum pulse rate of this unit is 10Hz.

$P_{average} = 5KW = 10^3(A) \times 100(V) \times 5 \times 10^{-3}(s) \times F(Hz)$, so
 $F = 5 \times 10^3 / 10^3(A) \times 100(V) \times 5 \times 10^{-3}(s) = 10Hz$.

**Even if user attempt to increase the pulse rate, the unit automatically decrease the pulse rate to limit the average power within the power ordered to protect the capacitor charging power supply of the unit.
 Or, If user attempt to increase the pre-determined pulse width, the unit becomes Fault condition.**

3.1.3 RISE TIME AND LOAD IMPEDANCE, OUTPUT VOLTAGE

As a general rule, the rise time is increased when LD voltage is lowered and LD current is increased, or load impedance is lowered.

Example 1):

LD Current =500A-1KA, Output Voltage =50V, then the fastest rise time will be: 1us-2us.

Example 2):

LD Current =500A-1KA, Output Voltage =300V, then the fastest rise time will be: 100ns-200ns.

As seen above, using higher output voltage unit has a great effect to the rise time improvement. There are two reasons to do so.

1. Overcoming the inductance:

As described in 2.3 OUTPUT STRIPLINE CONNECTION, there is certain amount of Output voltage is required to overcome the inductance that exists between the end of stripline and user's LD. This inductance L is the total of 1). LD-pin inductance plus 2). LD-internal lead wire inductance, plus 3). External lead wire inductance.

Example 1):

LD current =500A, Rise time required = 200ns, Total inductance L=100nH, Then, the required Output voltage to overcome this inductance $V_{required}$ is: $V_{required}=250V$,

Notice this voltage is used only for the inductance. If user's LD voltage is 50V, total voltage output voltage required from the unit is 300V.

2. Series Resistor:

As seen in the Example before, Increasing a load impedance is an easy choice to improve the rise time.

However, there are Pros and Cons for the higher voltage unit:

Pros:

1) Can improve the rise time dramatically.

Cons:

1) Unit becomes expensive.

2) There are certain heating loss at the series resistor.

3) Has to prepare a low inductance, high peak current, and high power resistor.

3.1.4 PRECAUTION

- 1). Do not shut off AC line voltage while the power supply is running. This is not a good manner from the safety point of view.
- 2). Confirm that Cur./Vol. Adj. is set to adequate level before turning Output SW. ON
- 3) Don't change Internal/External SW. while the unit is running.
- 4) Don't change Rise Time selection while the unit is running.

3.2 STARTING IN CW/PULSE MODE

3.2.1 WITH USING INTERNAL CLOCK

STEP 1. TURN AC CIRCUIT BREAKER AT BACK PANEL ON

Confirm READY will come on in 10-30 seconds.
Confirm output SW. is off position and Cur./Vol. Adj. Knob is zero position.

STEP 2. SWITCH Int./Ext. SW. to INTERNAL Mode.

STEP 3. TURN POWER SUPPLY SW. ON AFTER READY COMES

STEP 4. TURN OUTPUT ON/OFF SW. ON

For QCW unit, the setting voltage is slightly changed after the load current flowed. Adjust the voltage, if necessary.

STEP 5. ADJUST LOAD CURRENT

Watching Current waveform in the monitor scope, gradually increase the load current with Cur. /Vol. Adj. Knob.

STEP 6. SINGLE SHOT OPERATION

If the On/Off/S.Shot is switched to S.Shot position (down side), the output is appeared only one time. The pulse width is one time of the switch (CW mode), or a pulse width set by the Pulse Width adj. knob (Pulse Mode).

3.2.2 WITH USING EXTERNAL CLOCK

STEP 1. TURN AC CIRCUIT BREAKER AT BACK PANEL ON

Confirm READY will come on in 10-30 seconds.
Confirm output SW. is off position and Cur./Vol. Adj. Knob is zero position.

STEP 2. SWITCH Int./Ext. SW. to External Mode.

STEP 3. TURN POWER SUPPLY SW. ON AFTER READY COMES

STEP 4. TURN OUTPUT ON/OFF SW. ON

For QCW unit, the setting voltage is slightly changed after the load current flowed. Adjust the voltage, if necessary.

STEP 5. ADJUST LOAD CURRENT

By watching Current waveform in the monitor scope, gradually increase load current to desired level with Cur. /Vol. Adj. knob.

STEP 6. SYNCHRONIZE TO EXTERNAL PULSE

As seen in section 1.5.4 (Output On/Off/S.Shot), external pulse and On/Off SW. is not synchronized. If user want to synchronize the output pulse with user's gating signal, keep On/Off Sw. on position. Then, user's gated external signal control the output timing.

STEP 7. SINGLE SHOT OPERATION

If Int./Ext. SW is switched to External mode, Single shot is disabled and there is no current appeared on the output.

3.2.3 CURRENT WAVEFORMS

High QCW laser diode driver LD-XXXXQCW can generate the output pulse up to 1KA/1KV/1MW peak power. The followings show several sample waveforms took with this unit.

Note: If user want to see other waveforms, please contact to factory. We have many waveforms stocked.

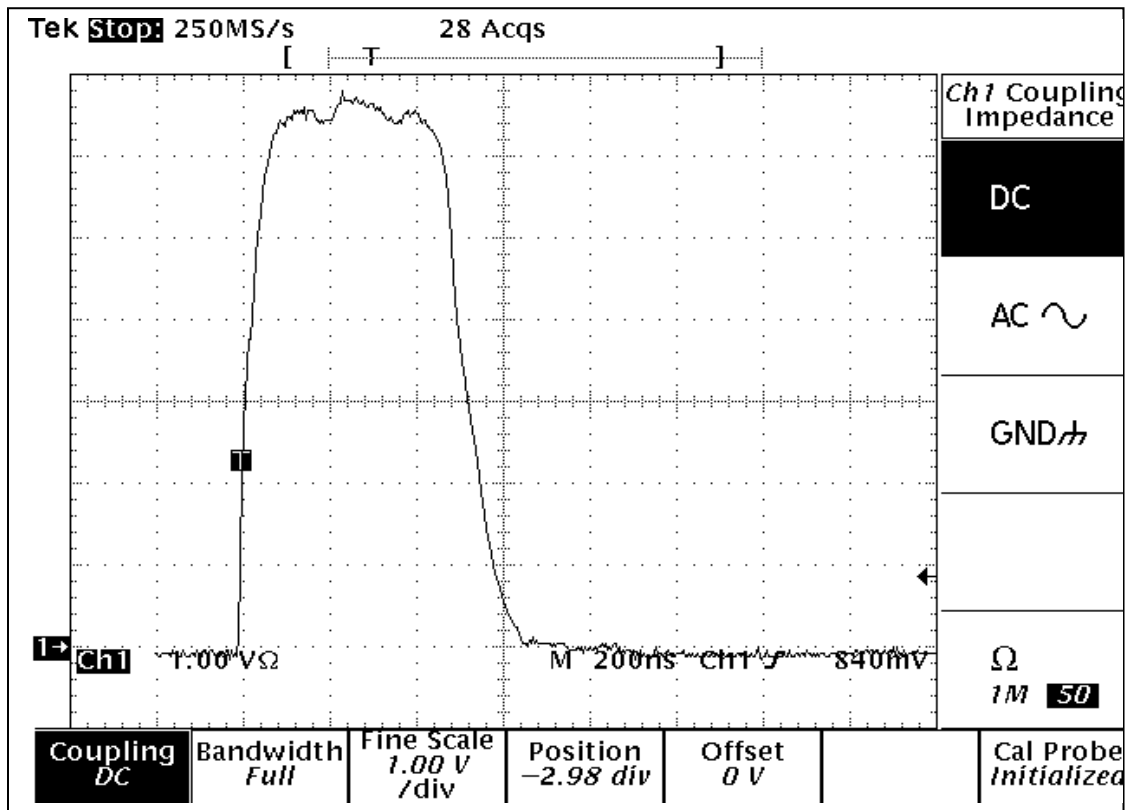
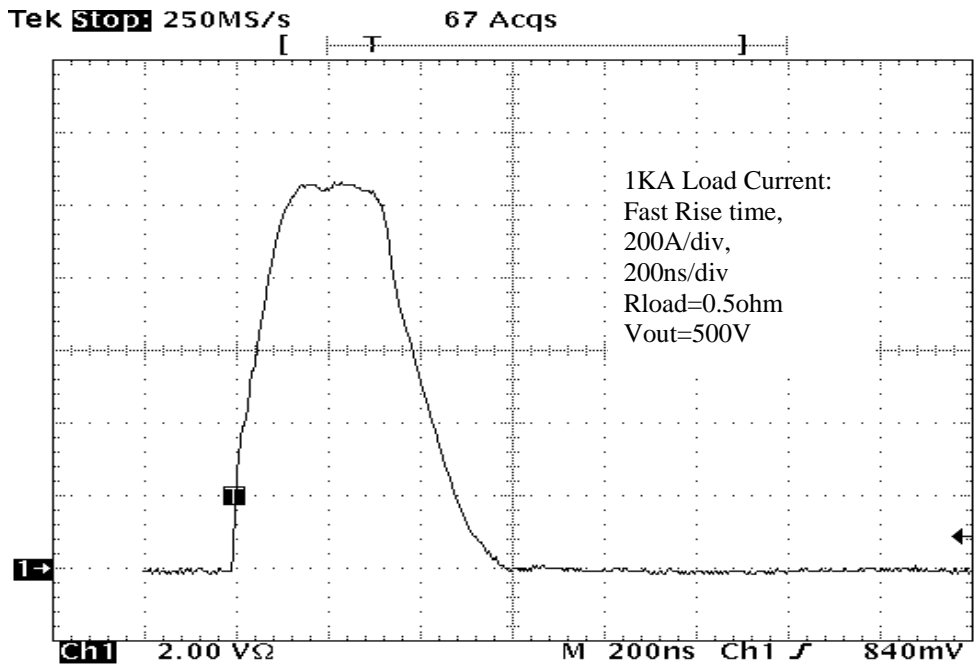

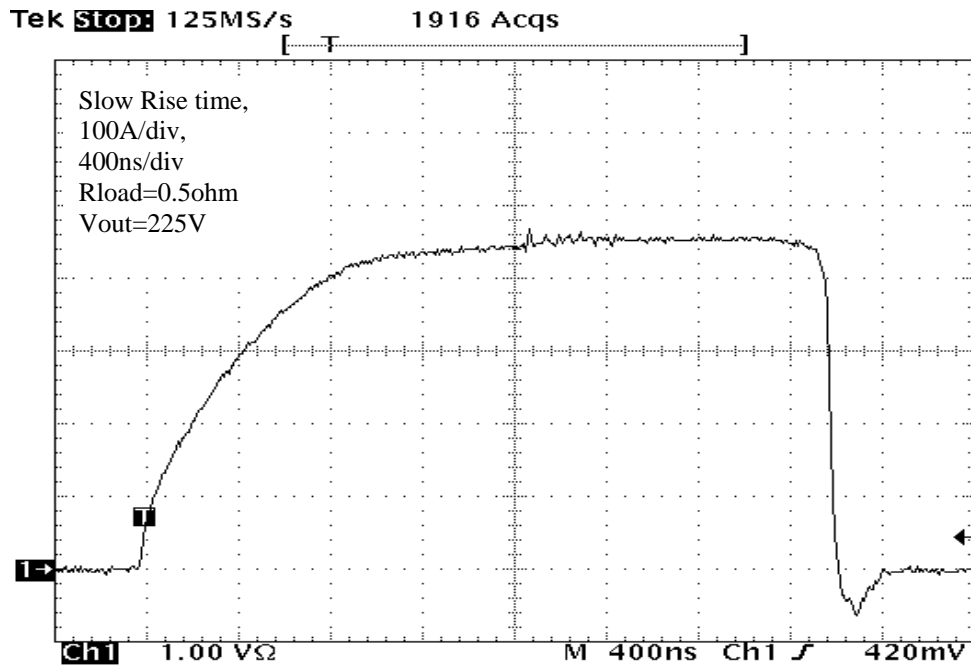

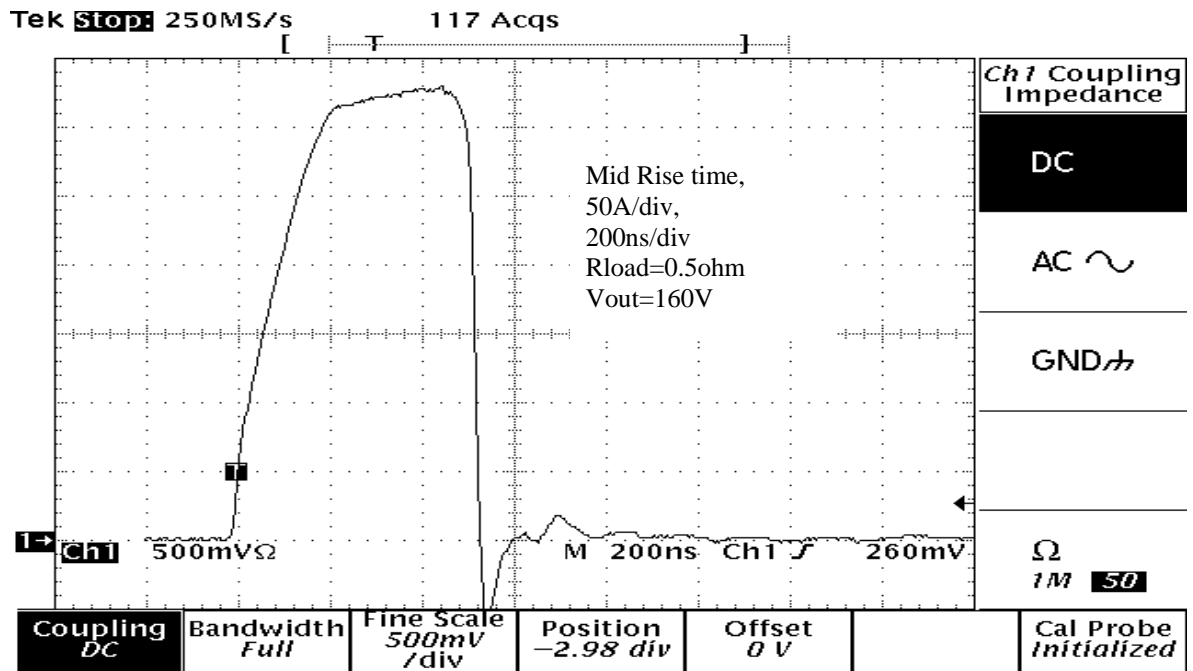
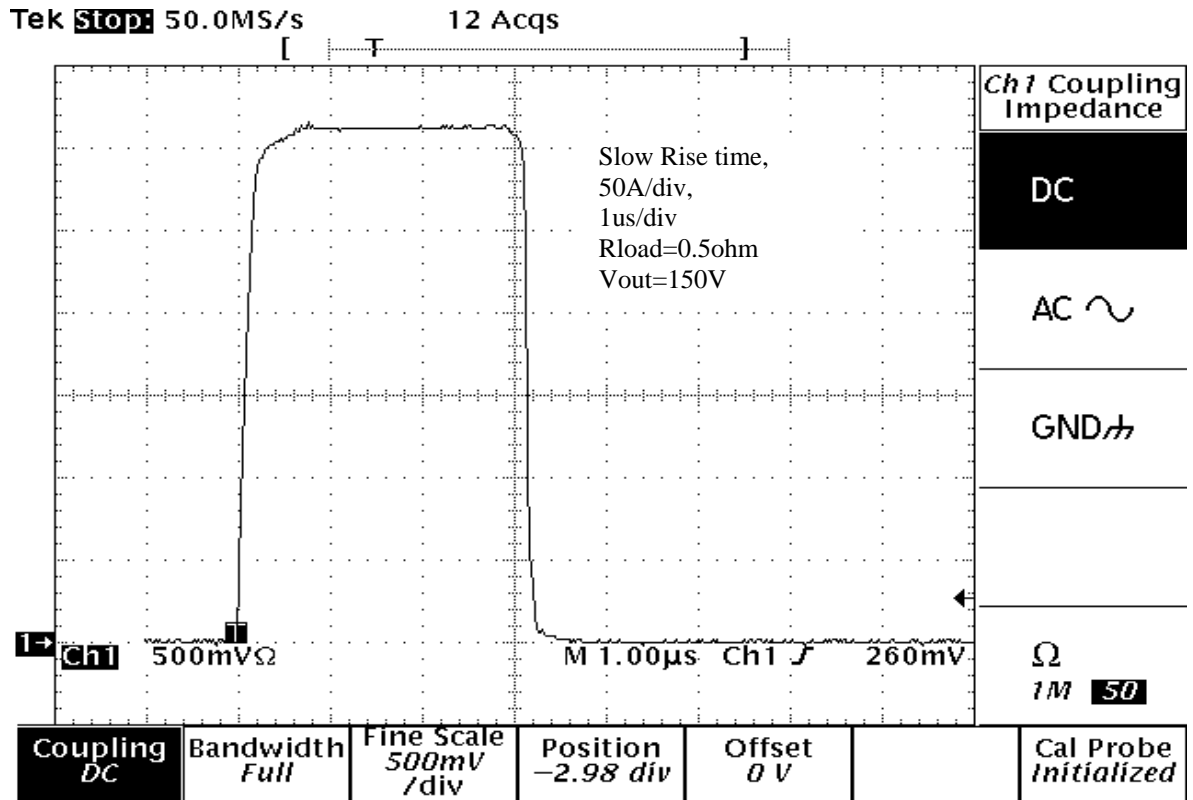

4.0 MAINTENANCE

4.1 GENERAL

Lic's laser power supply contains potentiometers that are set at Lic's factory. Do not try to adjust these potentiometers. **There are no user-serviceable parts in Lic's products.**

IF USER ATTEMPTS TO OPEN, ADJUST, MODIFY, OR REPAIR THE PRODUCTS, THEN LIC ENGINEERING CAN NO LONGER BE RESPONSIBLE FOR THE SAFE OPERATION OF THE UNIT, AND THE WARRANTY SHALL BE IMMEDIATELY VOID.

4.2 CAUTION

- 1). DO NOT ALLOW THE UNIT TO BE IN OPEN CIRCUIT.
- 2). DO NOT ALLOW THE UNIT TO BE SHORT CIRCUIT.
- 3). DO NOT ATTEMPT TO OPEN, MODIFY OR ADJUST ANY PARTS OF THE POWER SUPPLY.
- 4). DO NOT MECHANICALLY SHOCK.
- 5). KEEP WATER OR MOISTURE FROM THE UNIT EXCEPT IN-/OUTLET OF THE UNIT.
- 6). DO NOT MISUSE, OVERUSE, OR ABUSE THE UNIT.

4.3 TROUBLE SHOOTING

4.3.1 NOT READY SIGNAL COMES ON

CAUTION:

IF READY DOES NOT ON APPEAR WITHIN 60 SECONDS AFTER TURNING ON AC POWER OF THE UNIT, SWITCH AC POWER OFF IMMEDIATELY TO AVOID DESTROYING INTERNAL COMPONENTS.

- 1). Confirm that LASER and POWER signals stay at ground level.
- 2). Check all signal conditions including DC power line.

4.3.2 FAULT COMES ON

- 1). Check if Cur. Adj. is not set at the maximum. In certain case the first edge of the peak current is detected by an over current protection circuit.

4.3.3 OUTPUT DOES NOT APPEAR

- 1). Confirm READY is active, On/Off SW. is on, and Cur. Adj. signal has certain voltage levels.
- 2). Check Remote Interlock terminal (back side of the unit) is shorted.

4.3.4 ODORS OR UNUSUAL SOUNDS

If odors or unusual sounds are detected, turn AC Power off immediately. Contact Lic.

5.0 WARRANTY

Lic engineering warrants its products against all defects in materials and workmanship to the original using purchaser for a period of one year from the date of delivery to the original purchaser.

During this period, Lic engineering will repair or replace its products if defective free of charge. This warranty applies only when the products are properly installed, maintained and used for the intended purpose, and only to the original purchase/user of the products, and only so long as the products are used in the country to which it was originally shipped by Lic engineering, or by an authorized distributor.

Any shipping charge incurred shall be paid by the purchaser/user of the products.

This warranty is null and void if the user attempts to service the products (other than performing the maintenance described in the Instruction Manual), or if service is performed by people who are not trained and authorized to do so by Lic engineering.

THE EXPRESS WARRANTY ABOVE IS THE SOLE WARRANTY OBLIGATION OF LIC ENGINEERING AND THE REMEDY PROVIDED ABOVE IS IN LIEU OF GUARANTEES, OR WARRANTIES--ORAL OR WRITTEN, EXPRESS OR IMPLIED-- INCLUDING WITHOUT LIMITATION WARRANTY OR MERCHANTABILITY OR FITNESS FOR A PARTICULAR PURPOSE.

LIC ENGINEERING HAS NO LIABILITY WHATSOEVER FOR ANY INCIDENTAL OR CONSEQUENTIAL DAMAGE ARISING OUT OF ANY DEFECT, IMPROPER USE, OR UNAUTHORIZED SERVICE OR REPAIR.

5.2 RETURN OF THE UNITS

Prior to return of a unit, or any portion thereof, Lic engineering must be consulted to avoid unnecessary shipping.

If return of the units is deemed necessary, a Return Authorization Number "RAN" will be assigned. This number must be recorded on the outside of the shipping container.

Contact:

Lic engineering
3735 Coffey Lane
Santa Rosa, CA, USA
Tel: (707) 575 8821
Fax: (707) 526 3905
email: info@LicEngine.com