

Instruction Manual

**High Power Laser Diode Drivers/High Voltage Pulser/
High Voltage Pulse generator/Pockels Cell Driver
Models:**

**LSP-120/500/1500/2500/5000-XX-XX
LS-1000/2000
LPC-XXXX**



**This manual contains Operating, Safety, and
Maintenance information and subjects to change without notice.**



laser impulse company 

**LIC Engineering
122 Calistoga Rd.
Santa Rosa, CA 95409 USA
Phone: (707) 327-2705
Email: info@LicEngine.com**

2013 Rev.2.4

TABLE OF CONTENTS

SECTION	Pages
1. DESCRIPTION	
1.1 General -----	2
1.2 Description -----	3
1.3 Specification -----	4
1.4 Waveforms -----	5
2. INSTALLATION	
2.1 General -----	13
2.2 Inspection -----	13
2.3 Output Connection -----	13
3. OPERATION	
3.1 Preparation -----	17
3.2 Operation -----	17
4. MAINTENANCE	
4.1 General -----	19
5. WARRANTY	
5.1 Warranty -----	20
5.2 Return of the unit -----	20

Safety Precaution

Do not use this product in any manner not specified by the manufacturer. The protective features of this product may be impaired if it is used in a manner not specified in the operation instructions.

Before Applying Power

Verify that all safety precautions are taken. Make all connections to the unit before applying power.

Ground the Instrument

To minimize shock hazard, the instrument chassis and cover must be connected to an electrical ground. The instrument must be connected to the AC power mains through a grounded power cable, with the ground wire firmly connected to an electrical ground (safety ground) at the power outlet. Any interruption of the protective (grounding) conductor or disconnection of the protective earth terminal will cause a potential shock hazard that could result in personal injury.

Fuses and/or Circuit Breaker

Only fuses with required rated current, voltage, and specified type (normal blow, time delay, etc.) should be used. Do not use repaired fuses or short-circuited fuse holders. To do so could cause a shock or fire hazard. If circuit breaker is activated, take a careful inspection and don't repeat the breaker on/off.

Do Not Operate in an Explosive Atmosphere

Do not operate the instrument in the presence of flammable gases or fumes.

Do Not Remove the Instrument Cover

Only qualified, service-trained personnel who are aware of the hazards involved should remove instrument covers. Always disconnect the power cable and any external circuits before removing the instrument cover.

Do Not Modify the Instrument

Do not install substitute parts or perform any unauthorized modification to the product. Return the product to LIC Engineering factory for service and repair to ensure that safety features are maintained.

1.1

GENERAL

The LSP-XXXX-XX-series , LS-1000/2000-series & LPC-XXXX-series high power Laser Diode Driver/Pulse Generator/Pockels Cell Driver are designed to drive a laser diode, customer's specific load and Pockels Cell in LSP mode (Lic Super Pulse), which generates very high peak current and voltage up to 5KA and 15KV respectively with the rise times between 500ps-15ns (depend on the models selected).

Special made stripline connects directly from the driver to the Laser Diode/customer's specific load you use. The length of the stripline ranges from 1" to 15" depends on the models and applications.

This product can be also used for unique applications such as a Thyatron replacement, Plasma Discharge, Pockelscel driver, High voltage pulser, High voltage pulse generator, H.V trigger circuit, and High voltage Gas Discharge applications, where nano-second H.V pulse are required.

1.2

DESCRIPTION

The LSP-XXXX-XX-series , LS-1000/2000-series & LPC-XXXX-series high power Laser Diode Driver/Pulse Generator/Pockels Cell Driver contain 1) H.V power supply and 2) High speed switches, 3) Pulse forming network (optional) in one box. User does not need to prepare an extra H.V power supply to drive the driver. The H.V power supply is an ultra compact/high efficient power supply to supply the H.V source for the high voltage/high speed switching section.

Lic engineering is the original development company of the Super Pulse for laser applications since early 1980's in medical laser applications. **LSP; Lic Super Pulse** ranges from 100A to 5KA peak current and pulse width of 5ns to 100ns. To generate these high peak current, LIC Engineering uses several technics that have been accumulated for the past 35 years.

50 ohm BNC output is used to monitor the real time output current accurately. The attenuation ratio is 5mV/A-10mV/A depends on the specification selected.

The load current is sensed with an ultra small inductance and high power resistor that accuracy is +/- 1% and its inductance is extremely small.

1.3

SPECIFICATIONS of LSP-XXXX-XX, LS-1000/2000 & LPC-XXXX

1.3.1 AC INPUT

100V, 120V, 208V, 220V, 240V: +/- 10%, Single & Three phase, 47-63Hz.
Note: Other voltage ranges are also available by request.

1.3.2 OUTPUT POWER

Peak Power: 60KW-75 Mega Watts
Average Power: 1W-8KW for LSP-XXXX-XX-series & LS-1000/2000-series & LS-series & LDC-series

1.3.3 MAX. OUTPUT VOLTAGE

Between 500V and 20KV depends on the Models

Note:

Required Max. Voltage for User's Laser Diode depends on: 1) Required Peak Current, 2) Rise Time, 3) Total lead wire inductance: This is the total of A). LD-pin inductance plus B). LD-internal lead wire inductance, plus C). External lead wire inductance.

Please refer to 2.2 LASER DIODE CONNECTION

1.3.4. MAX. PEAK OUTPUT CURRENT

Between 500A – 5KA depends on the Models Name

Note: Max. Peak Current depends on the Total wire inductance of the Laser Diode used.

Refer to 2.2 LASER DIODE CONNECTION

1.3.5 OUTPUT POLARITY

Negative(Standard).

1.3.6 OUTPUT CURRENT RISE TIME

The rise time can be set as follows

1). Less than 500ps-2ns: up to 500A.

2). Between 2-3 ns and 15ns: up to 5KA

1.3.7 MAXIMUM REPETITION RATE

Between 10Hz and 5MHz depends on the Models

1.3.8 MINIMUM PULSE WIDTH

5ns

1.3.9 PULSE DUTY

1-100%

1.3.10 AUXILIARY POWER SUPPLY for LDC-Series

LDC-Series requires an external power supply to drive the driver. This specification depends on the driver you ordered.

1.3.10 External Signal

LSP/LDC-Series can use both internal and external drive signal for the driver. 1K ohm BNC connector is used for this purpose.

1.3.11 OPERATING TEMPERATURE

Ambient temperature: +10 to 40C

1.3.12 OUTPUT CONNECTORS

Direct Stripline Connection: Stripline length is 1" – 15"

1.3.13 CURRENT MONITOR

BNC 50 Ohm: Attenuation Ratio is 10mV/A – 100mV/A

1.3.14 EXTERNAL CONTROL INPUT

BNC 1K Ohm

1.3.15 DIMENSIONS(LxWxH inch)

Please refer to each product

1.3.16 WEIGHT(Lb.)

Please refer to each product

1.4 **Sample Waveforms**

High Peak Power laser diode driver/High Voltage Pulser LSP-XXXX can generate the output pulse up to 5KA/15KV/75MW peak power. The followings show several sample waveforms took with several different units of LSP-series.

Note: If user want to see other waveforms, please contact to factory. We have many waveforms stocked.

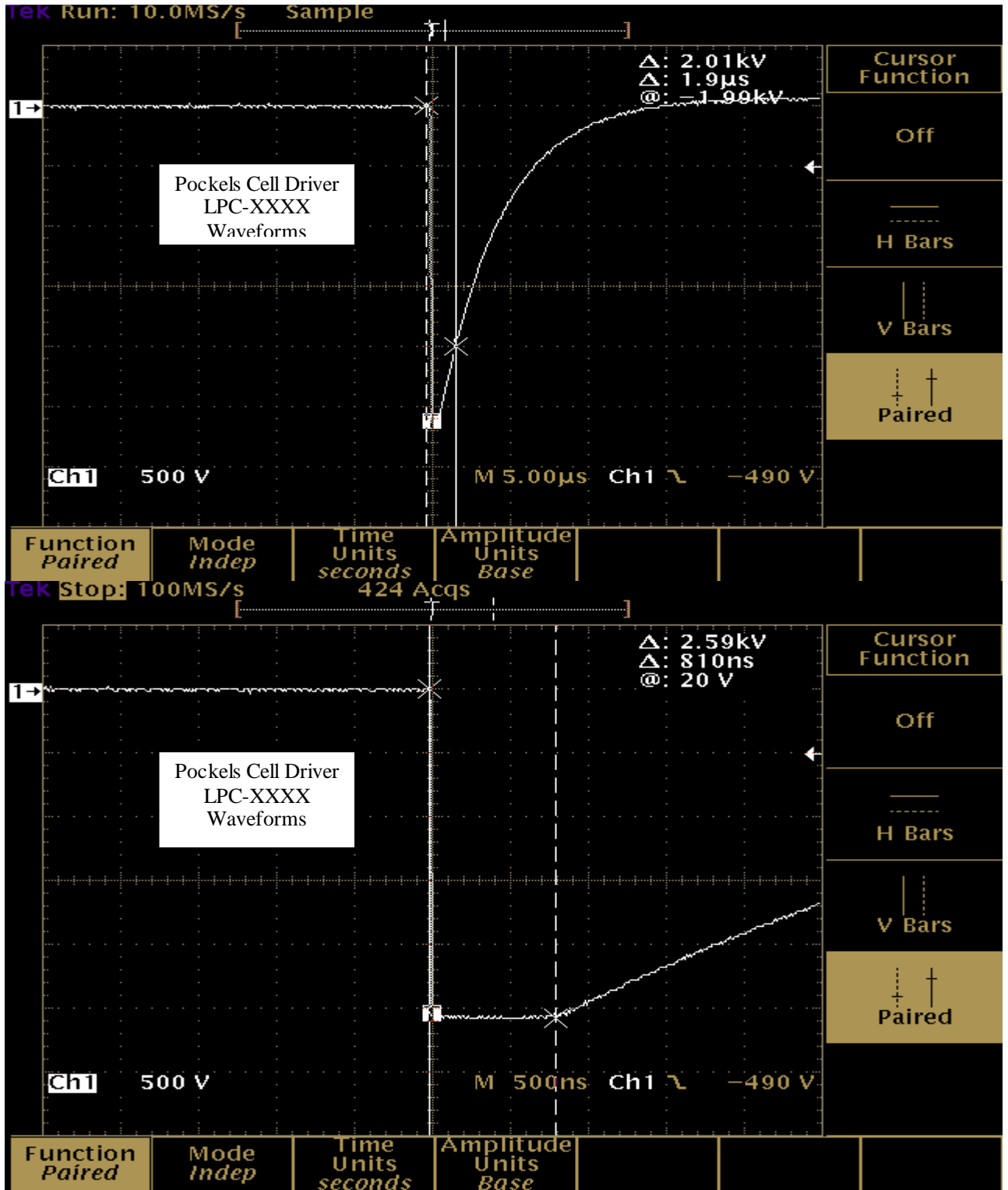

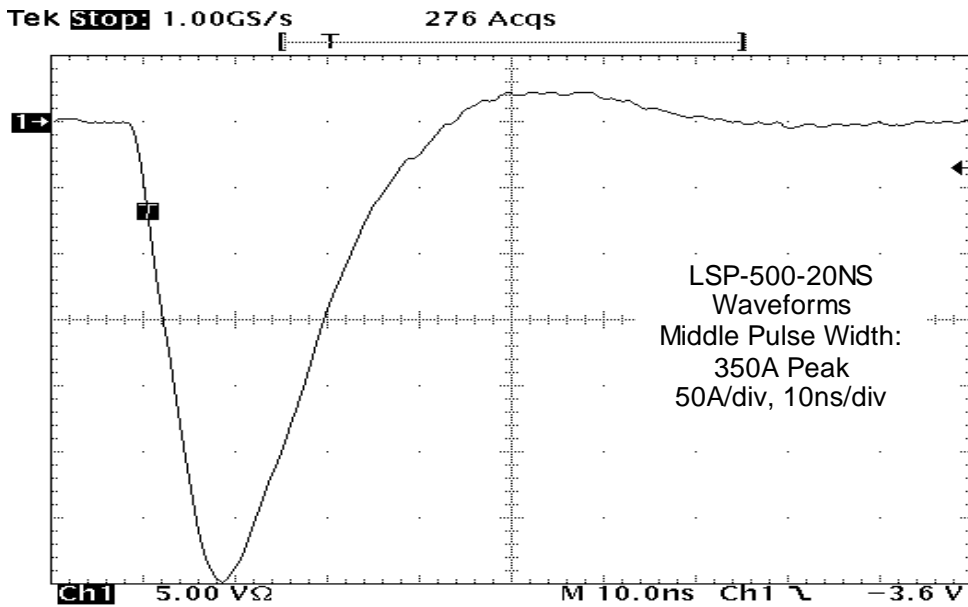
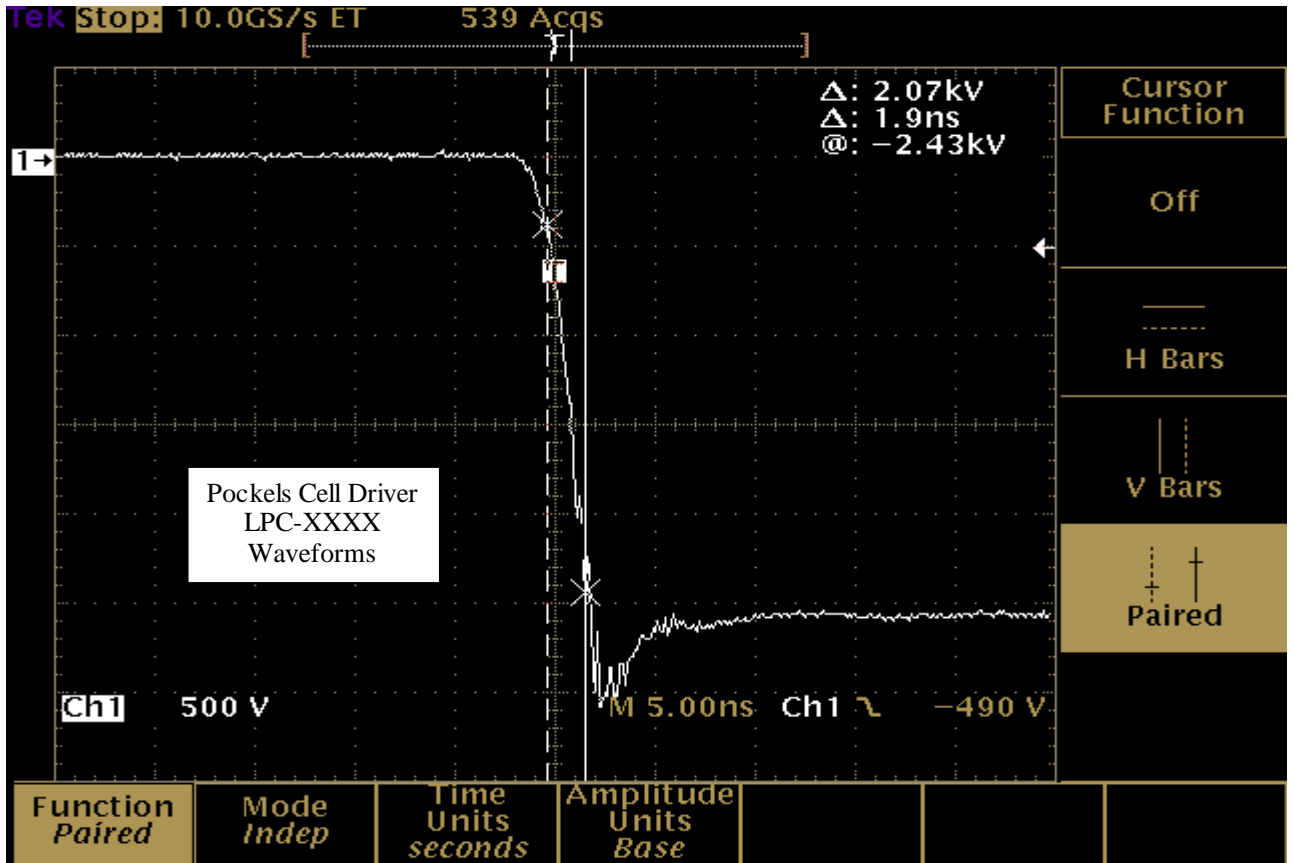

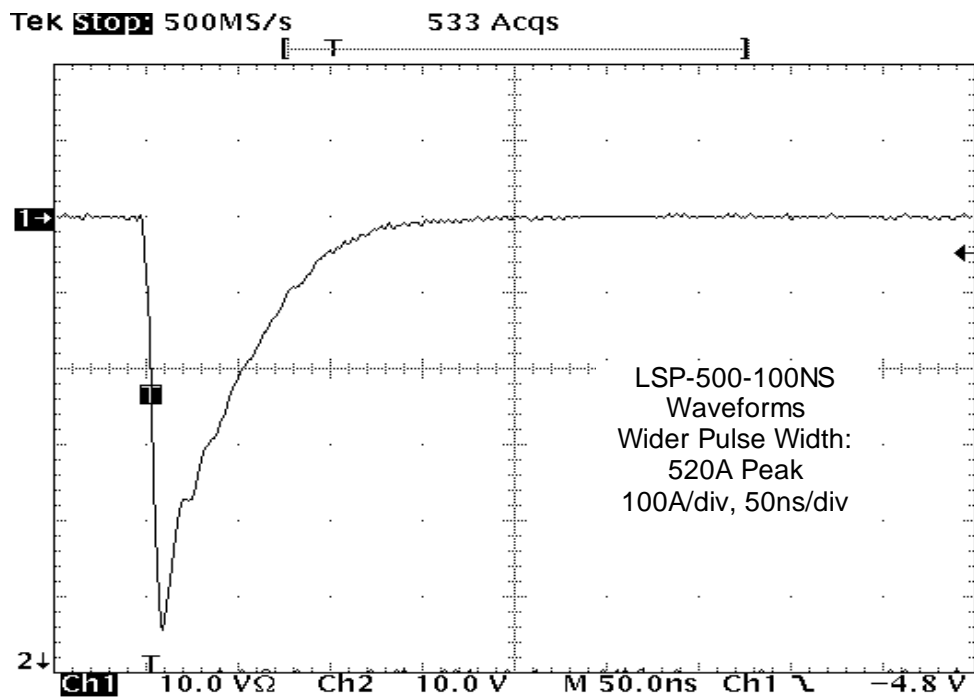
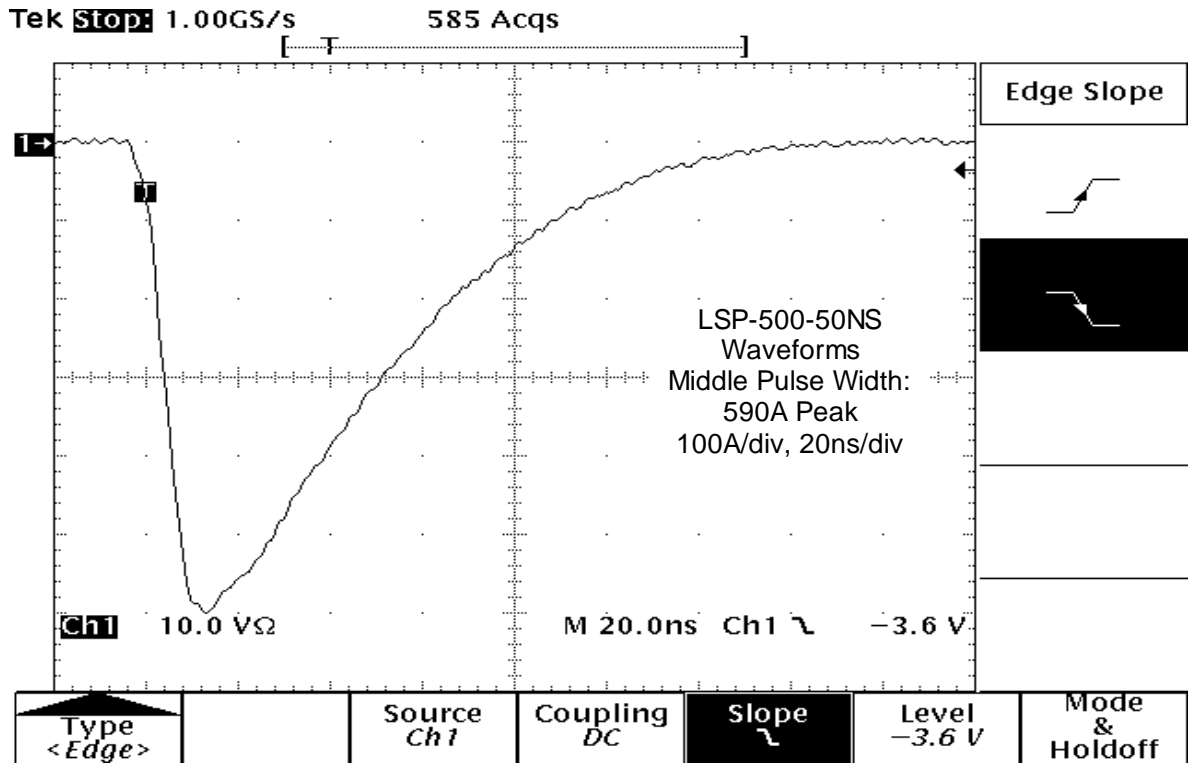

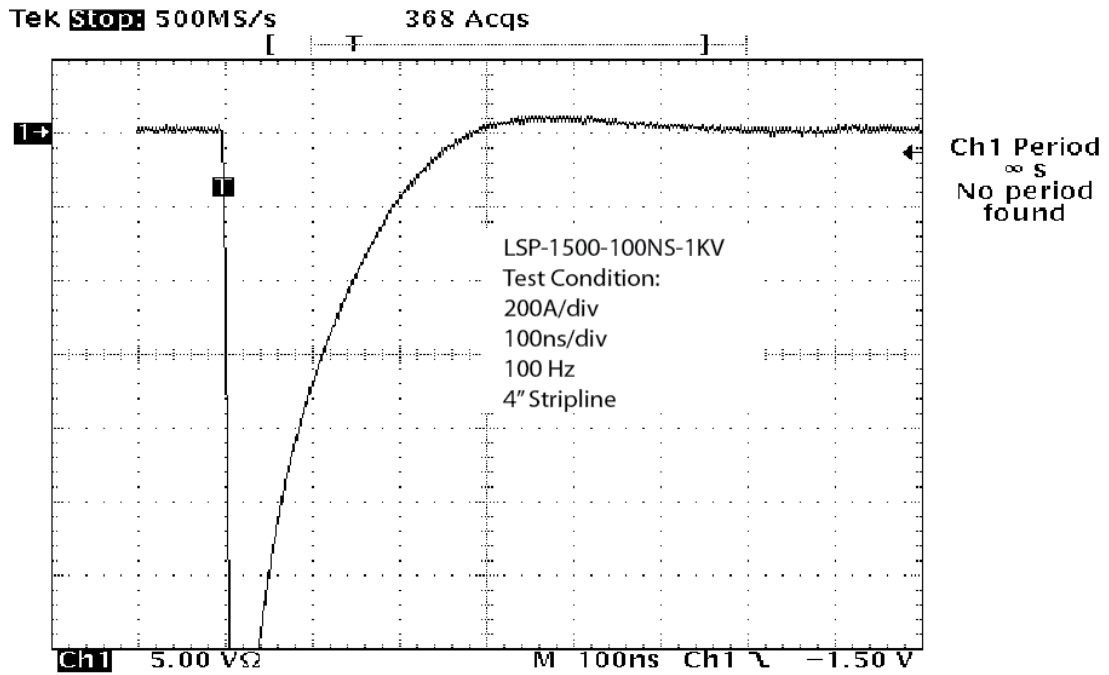
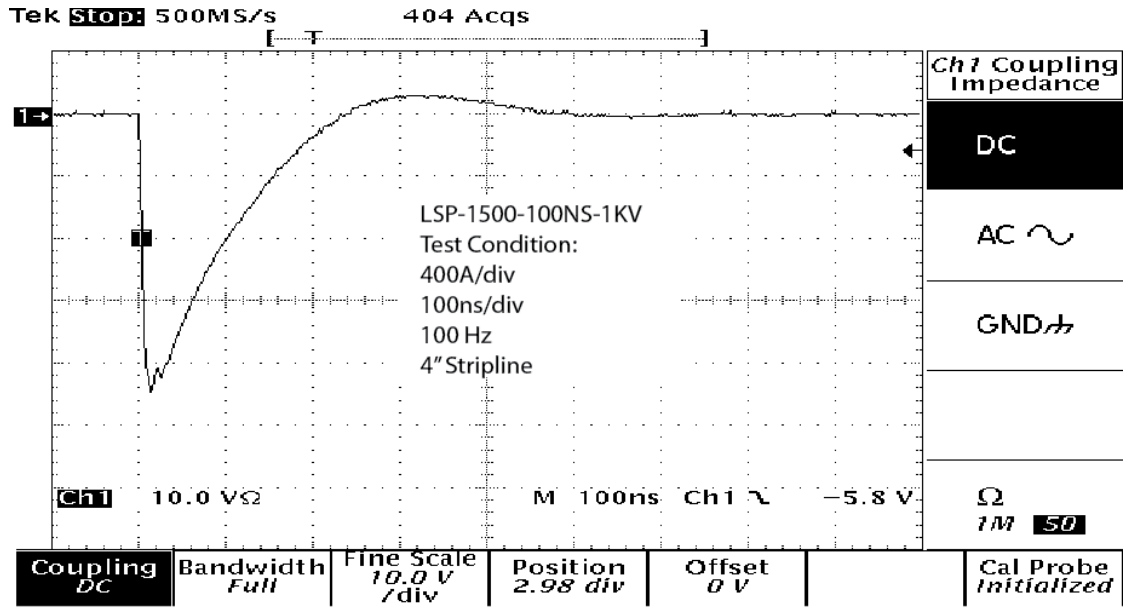

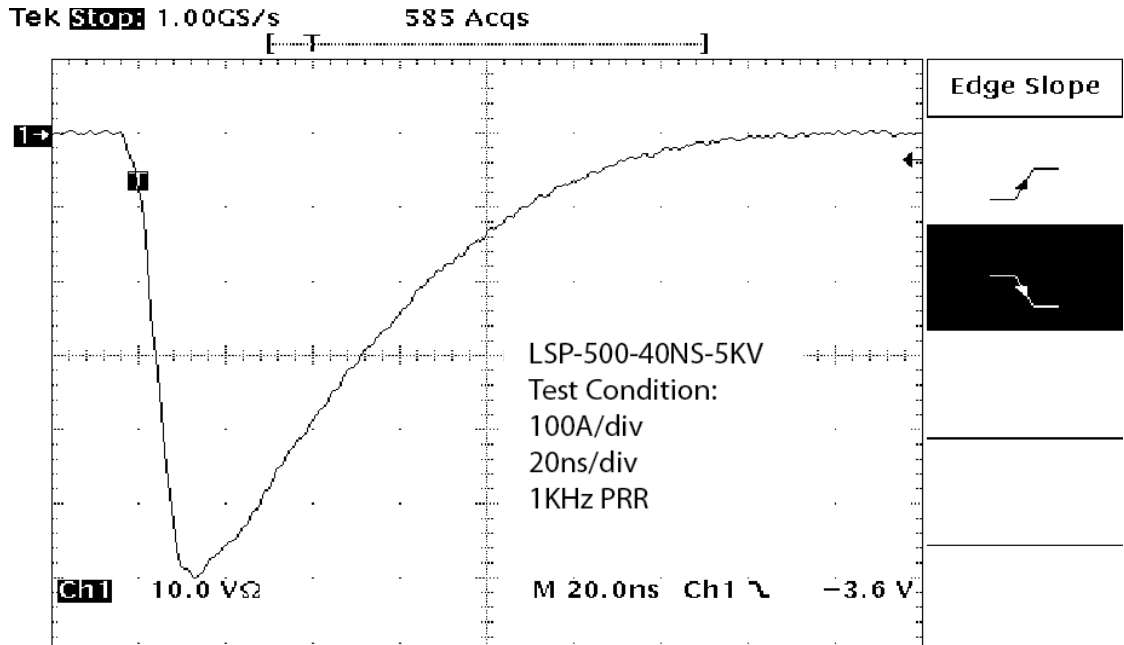

Type <Edge>	Source Ch1	Coupling DC	Slope ↘	Level -3.6 V	Mode & Holdoff
----------------	---------------	----------------	------------	-----------------	----------------------

Tek **Stop:** 500MS/s 184 Acqs

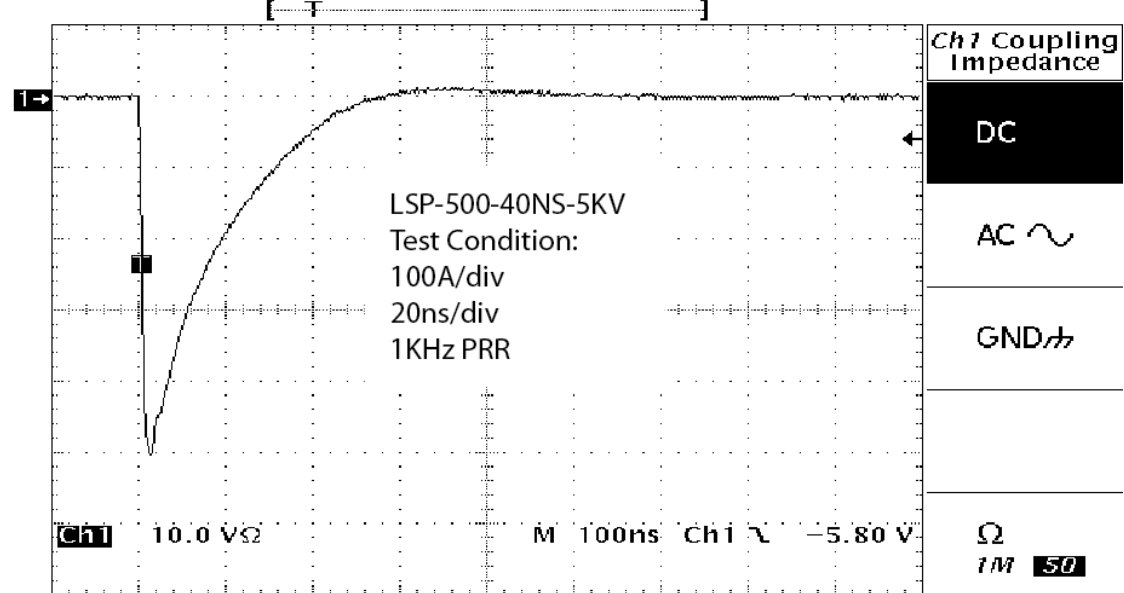

Coupling DC	Bandwidth Full	Fine Scale 10.0 V /div	Position 2.98 div	Offset 0 V	Cal Probe Initialized
----------------	-------------------	---------------------------	----------------------	---------------	--------------------------

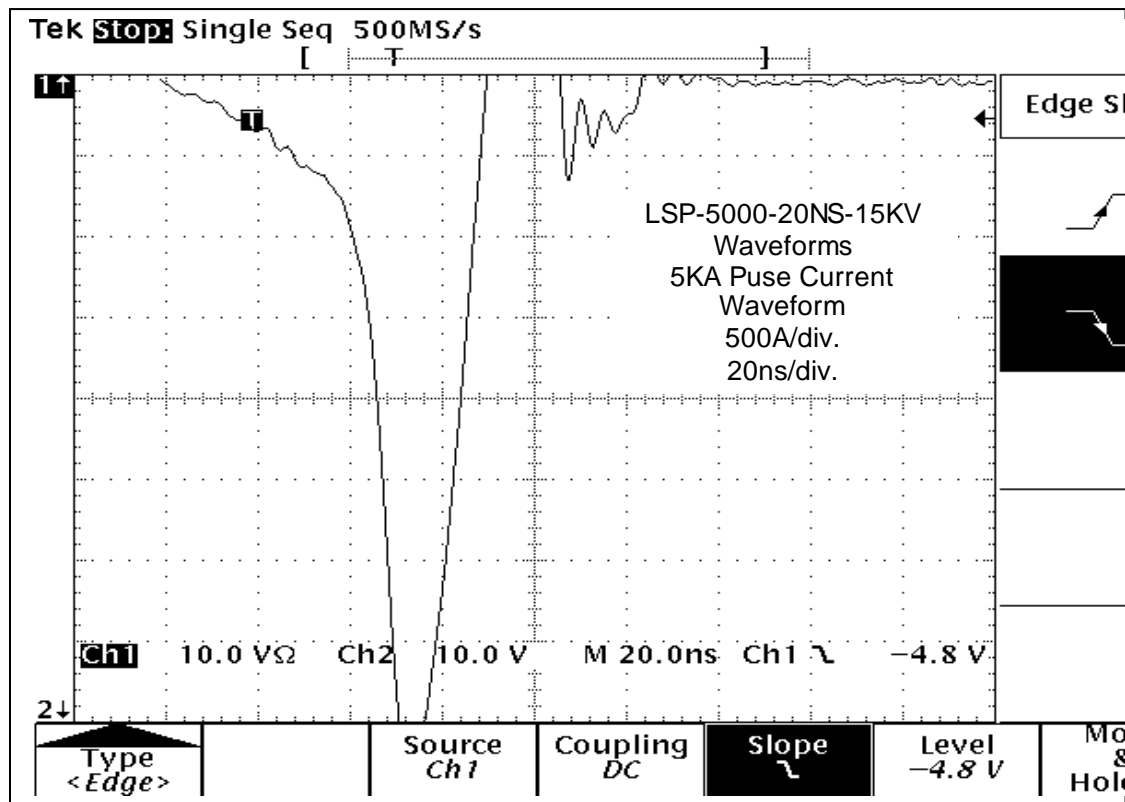
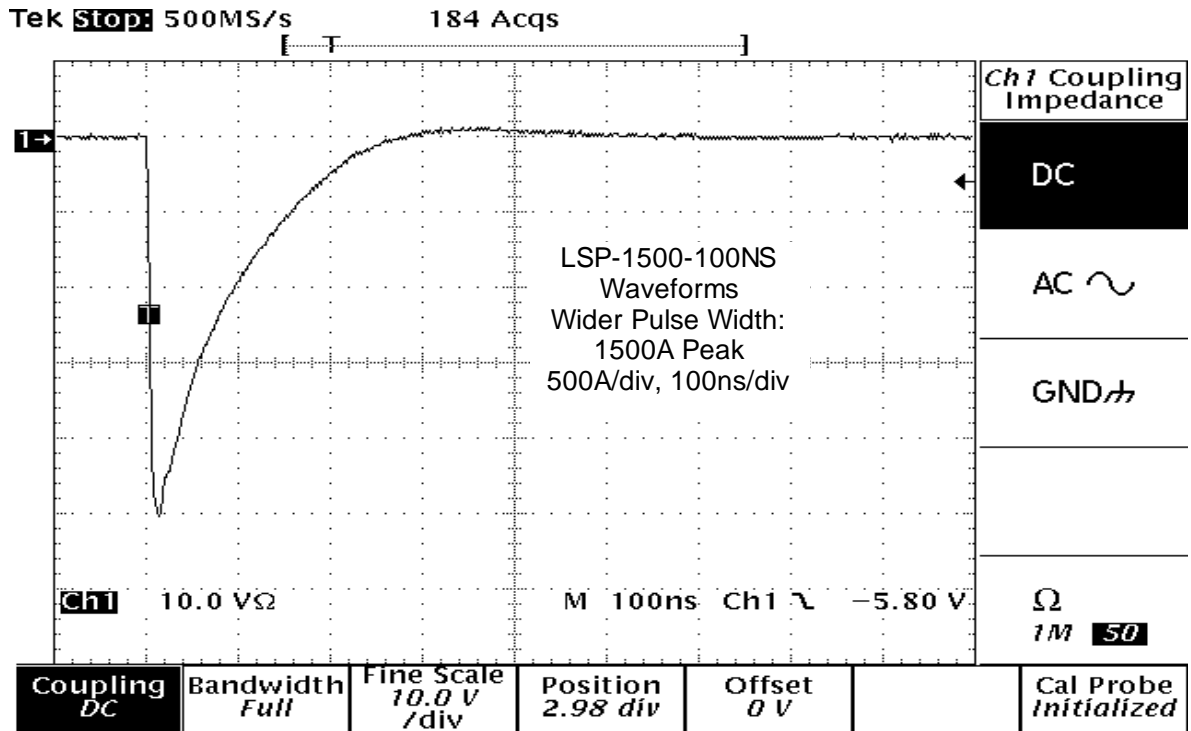

Tek **Stop:** Single Seq 1.00GS/s

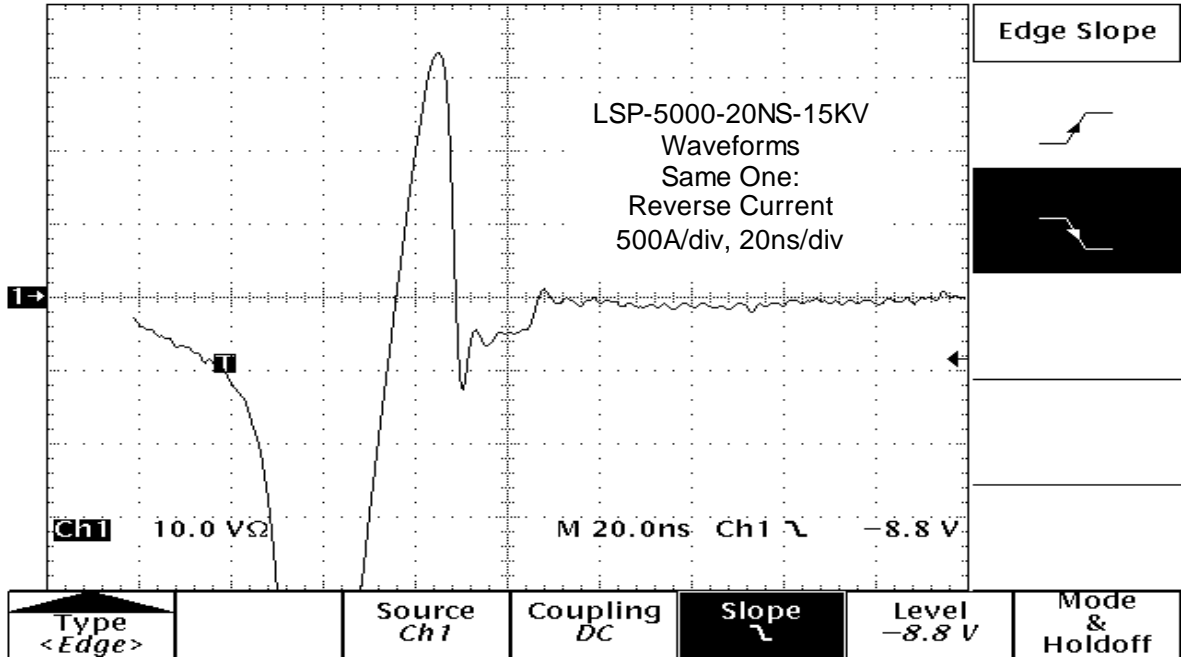

Tek **Stop:** 1.00GS/s 239 Acqs

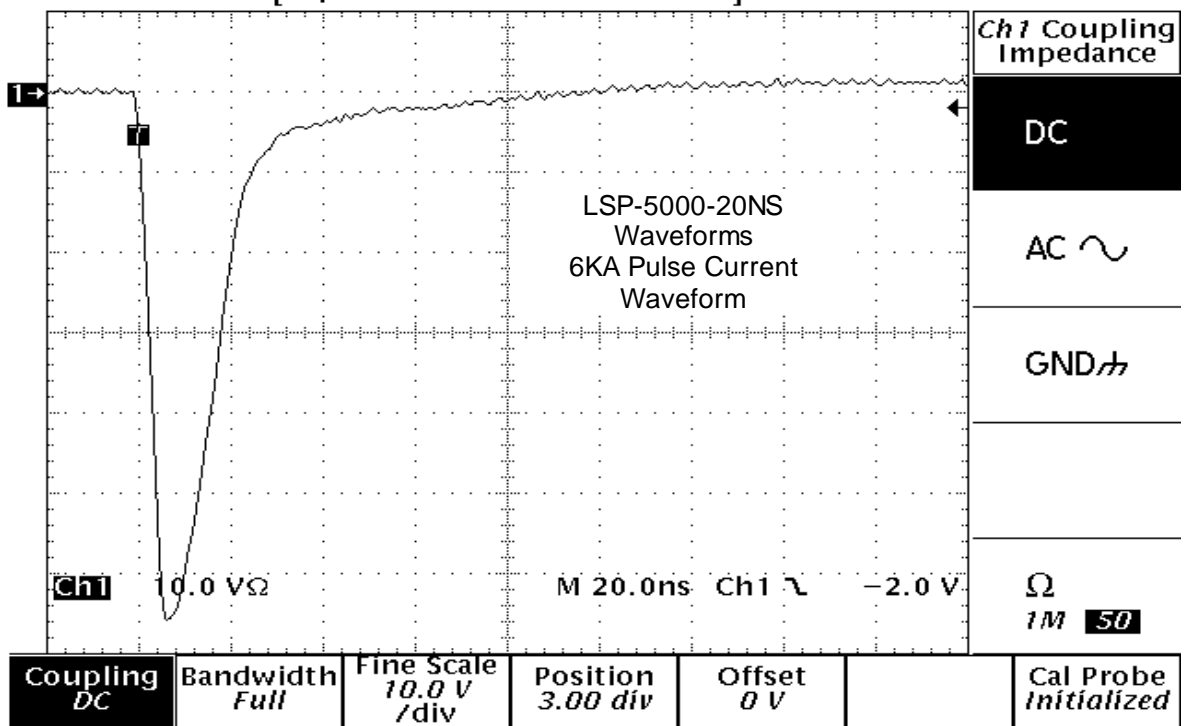

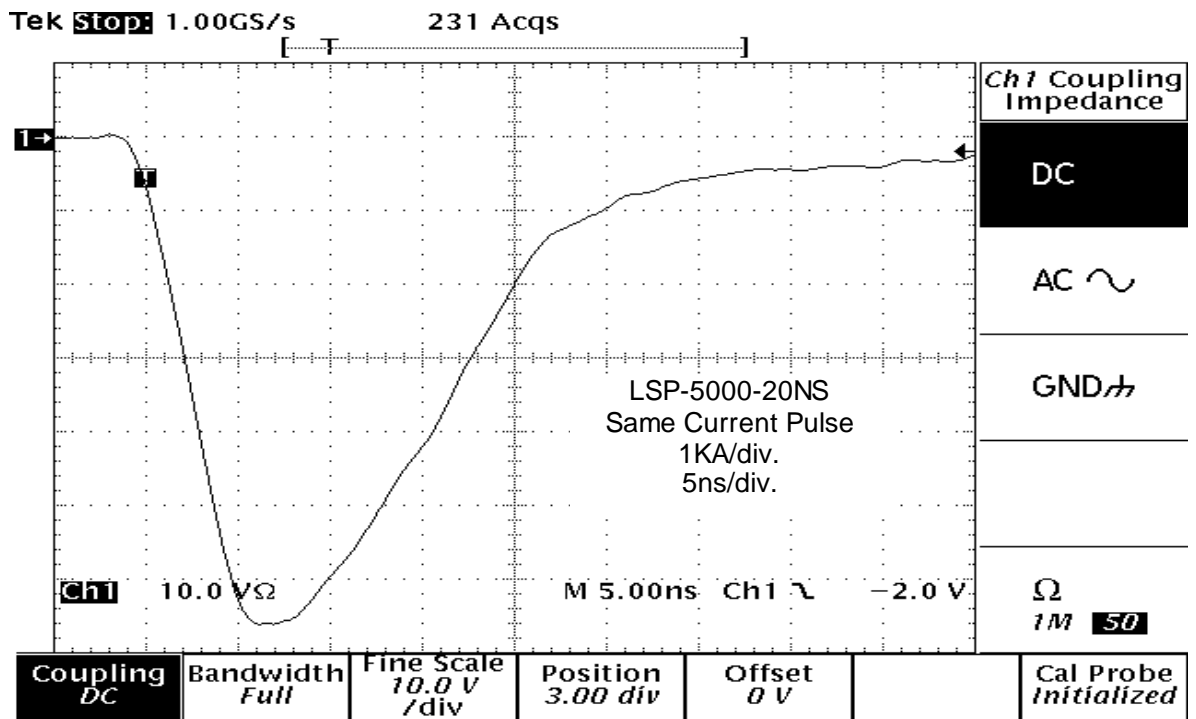

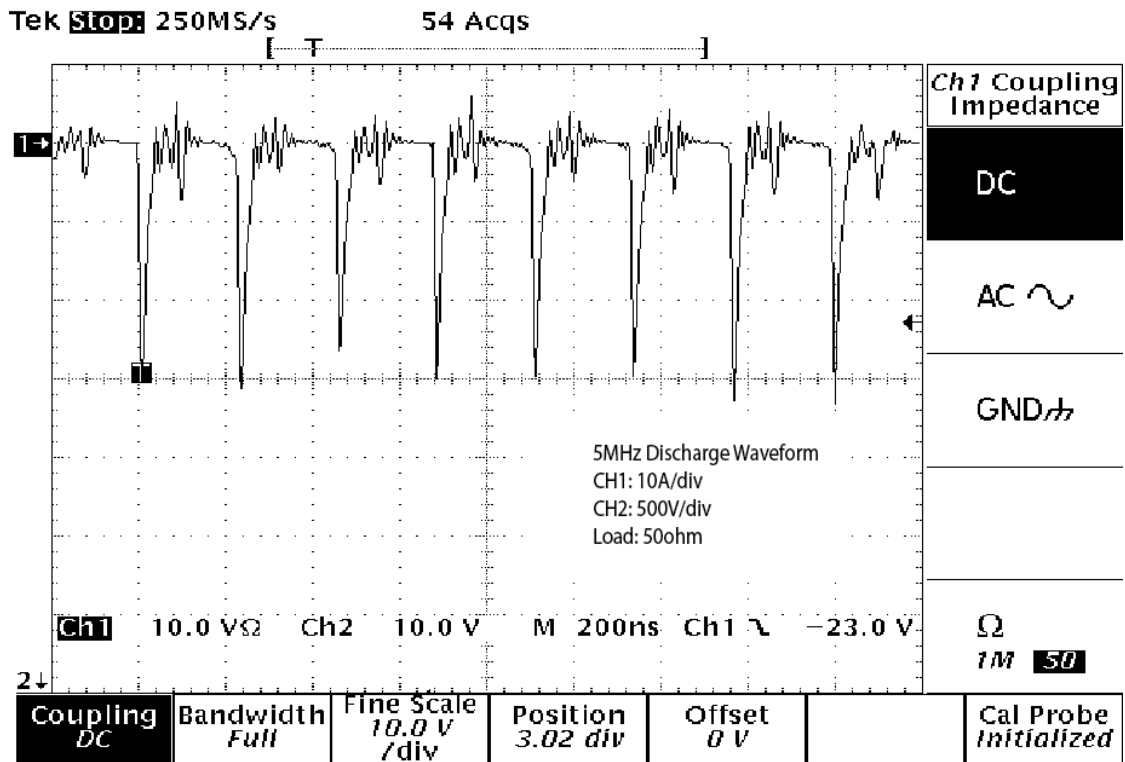
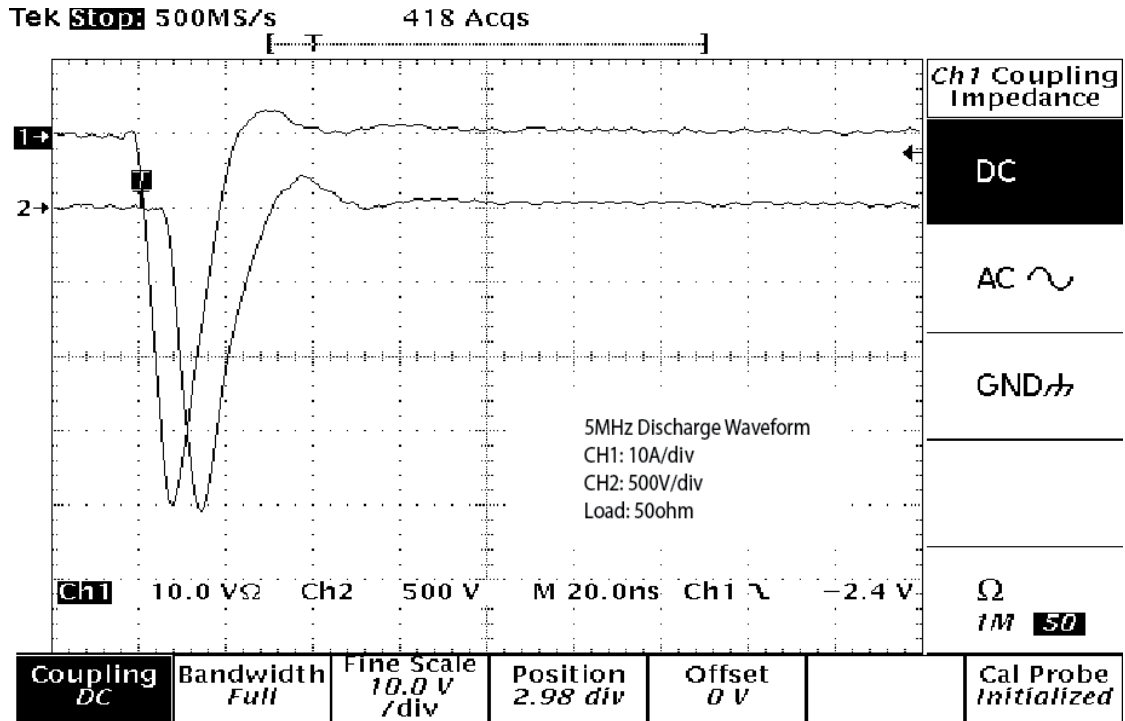

2.0 INSPECTION

Check for damage incurred during shipment as follows:

1) Inspect unit case for cracking, bending, and other obvious signs of damage.

2.1 POWER CORD CONNECTIONS

Connect the AC power cord supplied to LSP-EVBD. Make sure GND wire is connected to the GND terminal on the board.

2.2 LASER DIODE CONNECTION

Connect the laser diode to the one of each output. **Be careful for the lead wire inductance:**

If the lead wire is not short enough, then the peak current is lowered and the rise time becomes slow.

Refer to the following famous formula:

$$V(v)=L(nH) \times dl(A)/dt(ns)$$

Where, V=voltage across the lead wire (V), L=lead wire inductance (nH), DI=peak diode current (A), dt=rise time (ns)

Please notice that in LSP-XXXX-XX-series & LS-1000/2000-series high voltage laser diode driver, almost 100% of the output voltage is used to overcome the inductance. This inductance L is the sum of 1). LD-pin inductance plus 2). LD-internal lead wire inductance, plus 3). External lead wire inductance.

Example 1):

LD current =500A, Rise time required = 3ns, Total inductance L=10nH,
Then, the required Output voltage to overcome this inductance V_required is:
V_required=1.7KV,

Example 2):

LD current =2500A, Rise time required = 5ns, Total inductance L=30nH,
Then, the required Output voltage to overcome this inductance V_required is:
V_required=15KV.

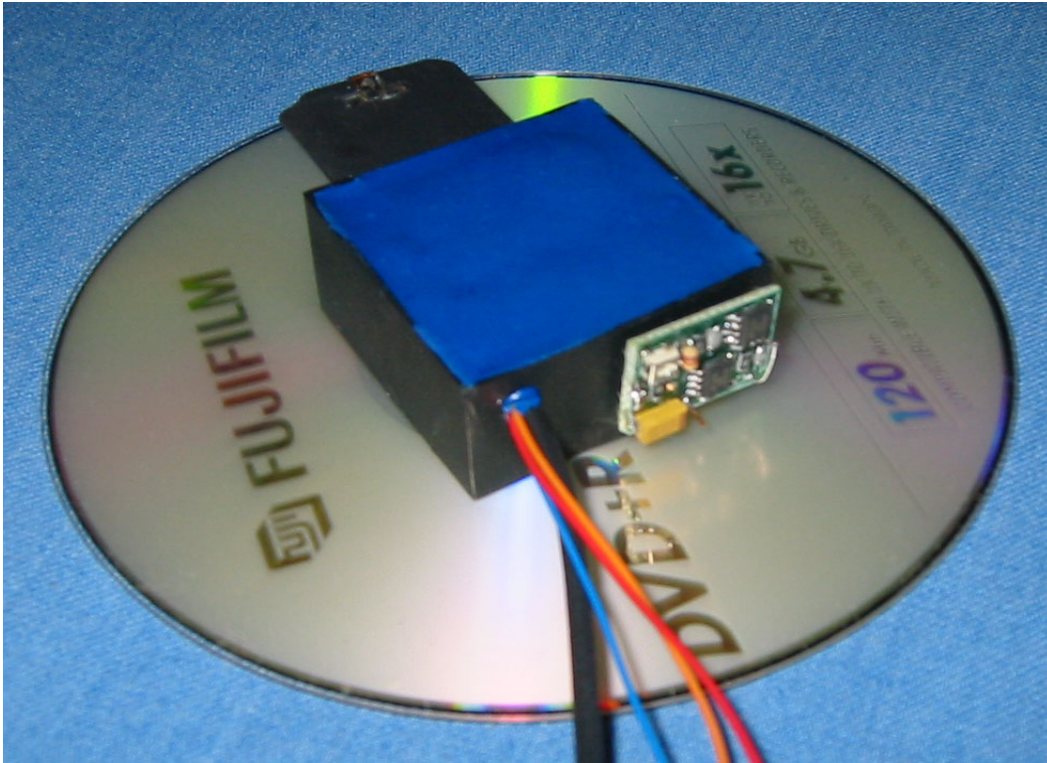

(LSP-120 LD Driver)

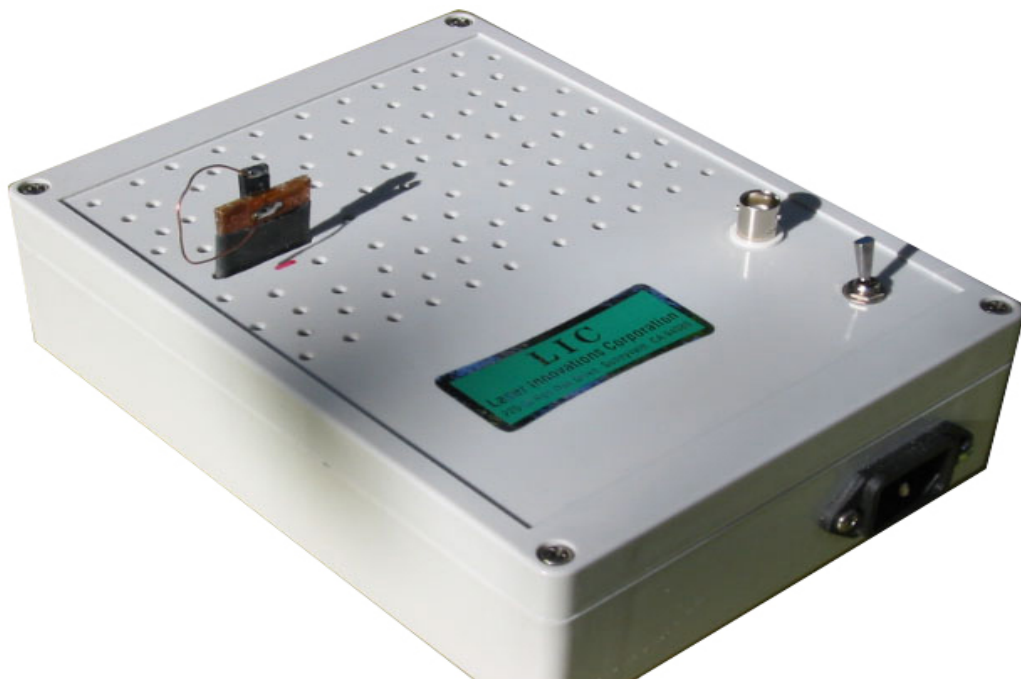

(LSP-2500-20N-15KV Driver)



(LSP-5000-20N Driver/Pulse Generator)



(LSP-XXXX-XXX-XX Driver)

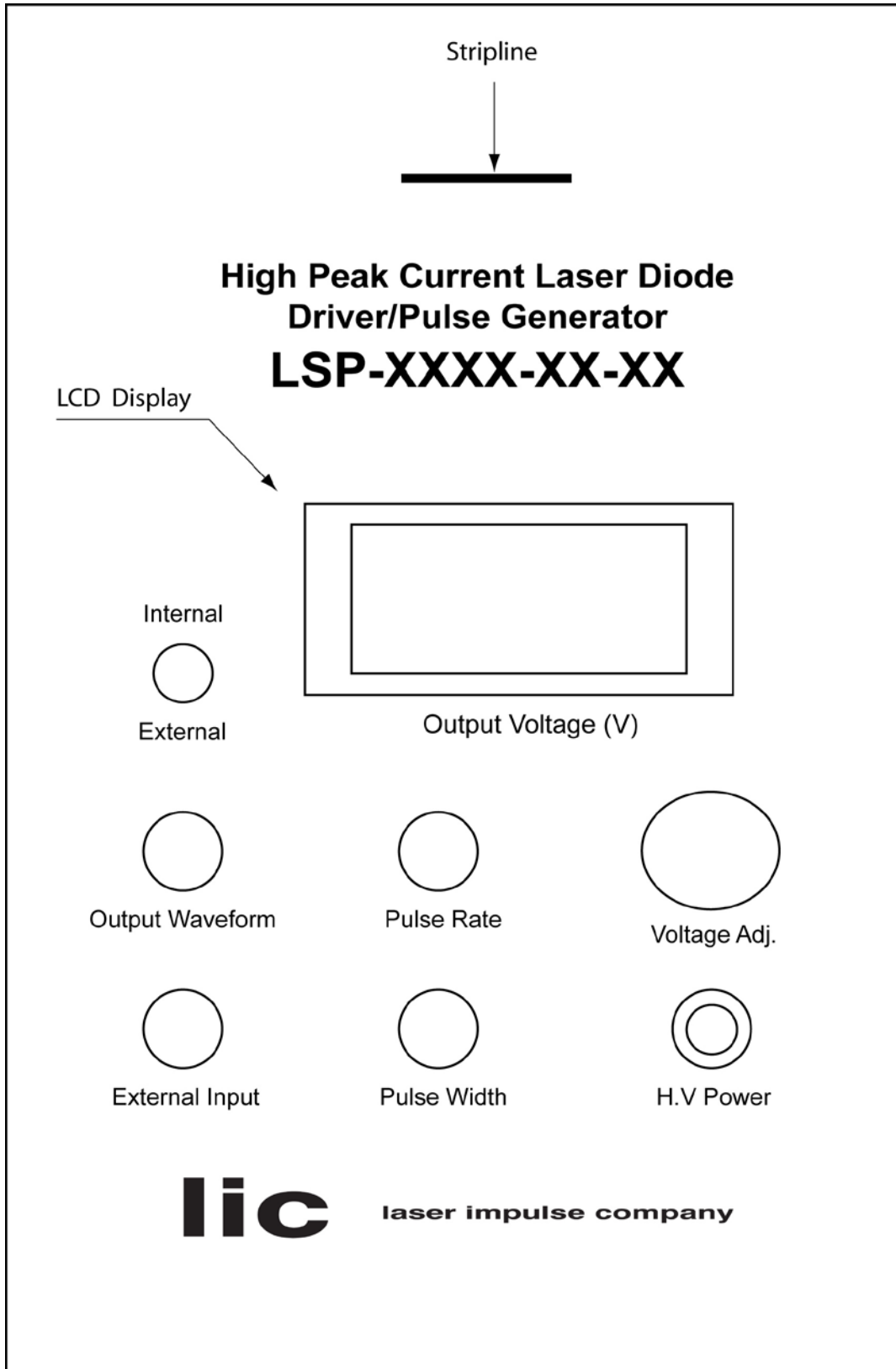

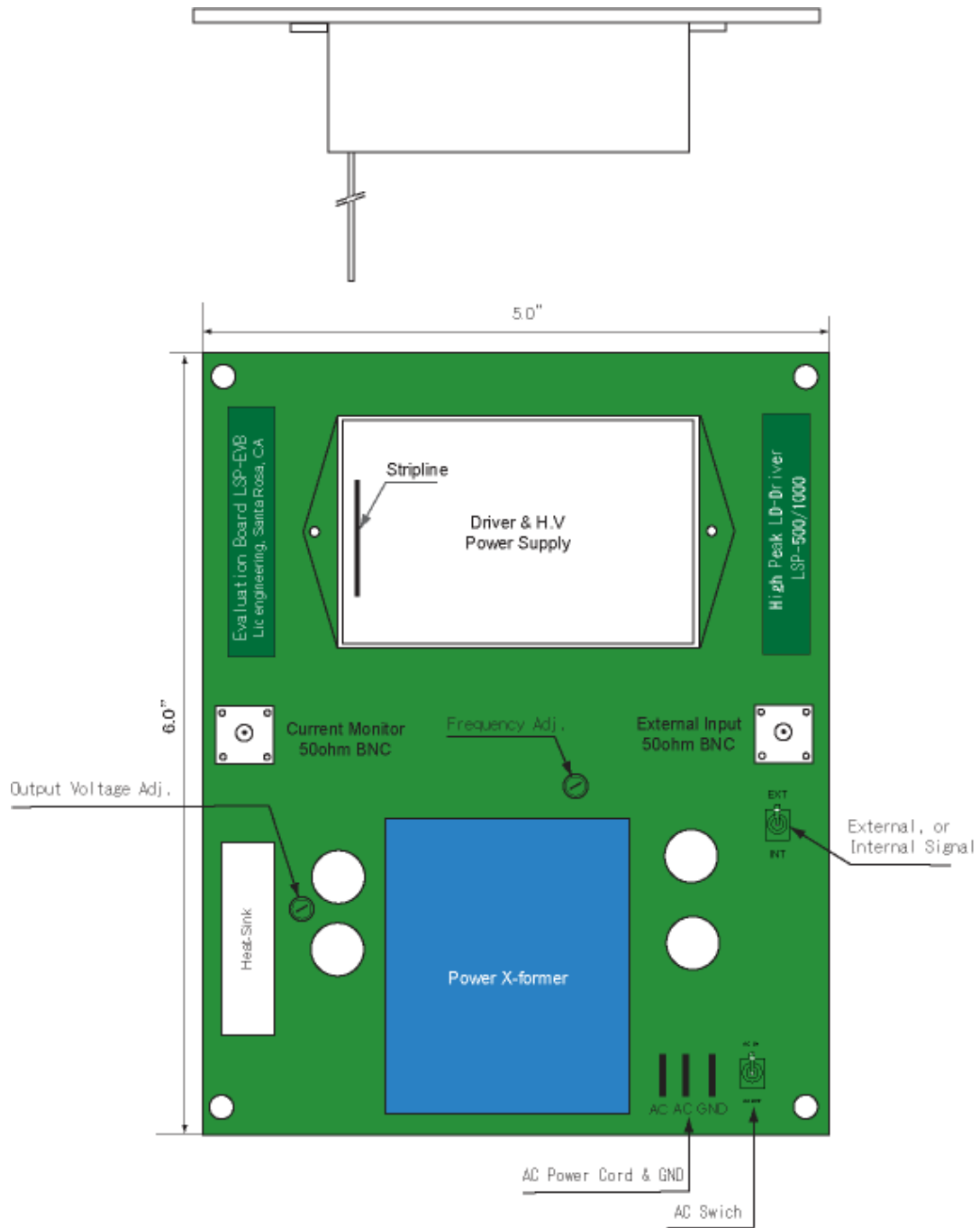

(Evaluation Board)

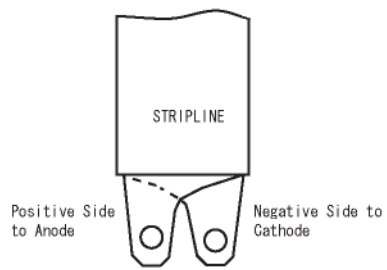
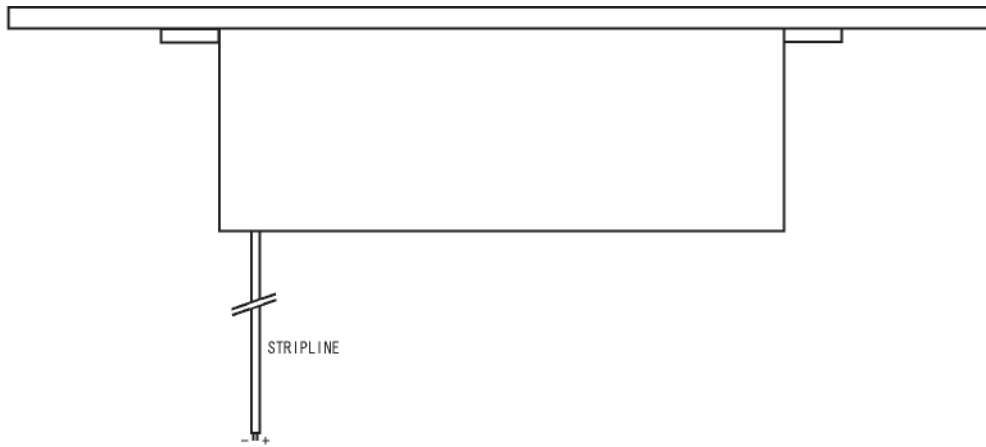

(1) For Screw Type Terminal

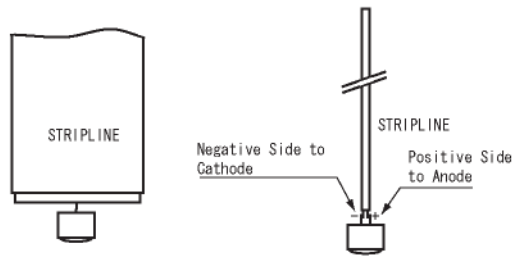

(2) For Pin Type Terminal

500A Driver internal circuitry

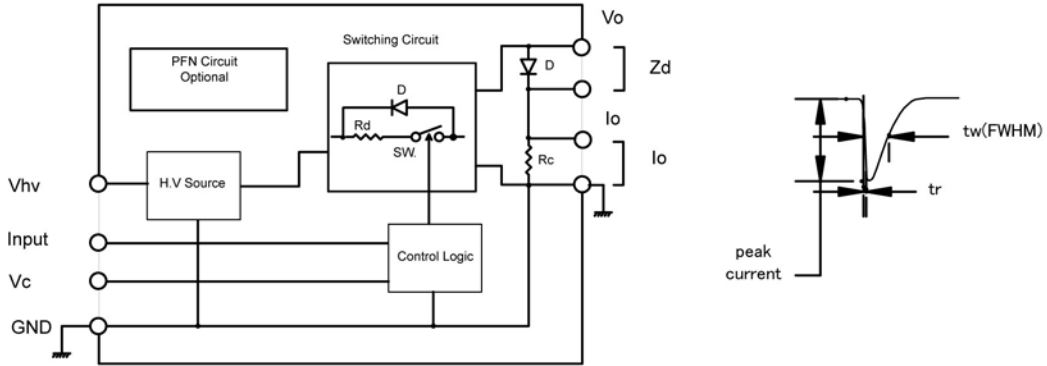

Vhv: H.V Source voltage (DC10-12V/0.3A)
 Input: Pulse input 10-15V, tr 10ns
 Vc: Control circuit voltage (DC25-30V/0.1A)

SW: Switching device
 D: Protection diode
 Rc: Current sensing resistor
 Rd: Internal resistance

Zd: Load impedance
 Vo: Output Voltage
 Io: Load Current Sensing Output (10A/V)
 Note: Io is not available when Zd is connected between GND & Vo

Mechanical Dimension (1.5-3KV model)

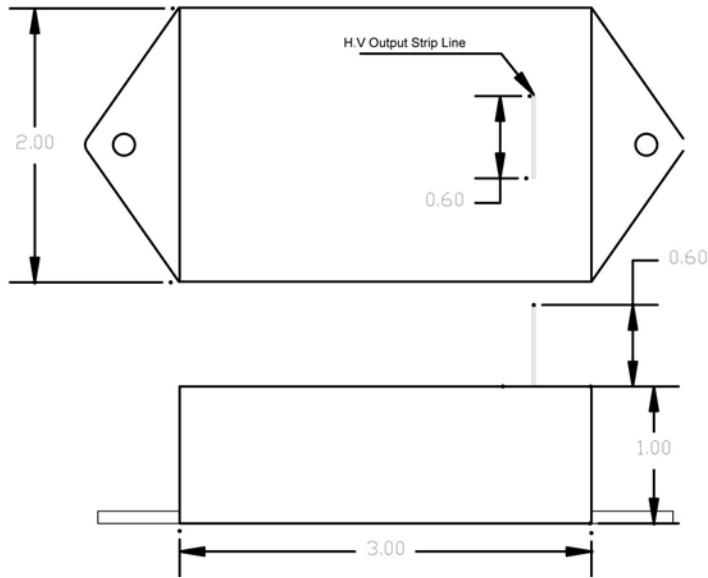



(LSP-500-50N-1KV LD Driver)



(LS-1000 Pulse Generator/Driver)



(LS-2000 Pulse Generator/Driver)

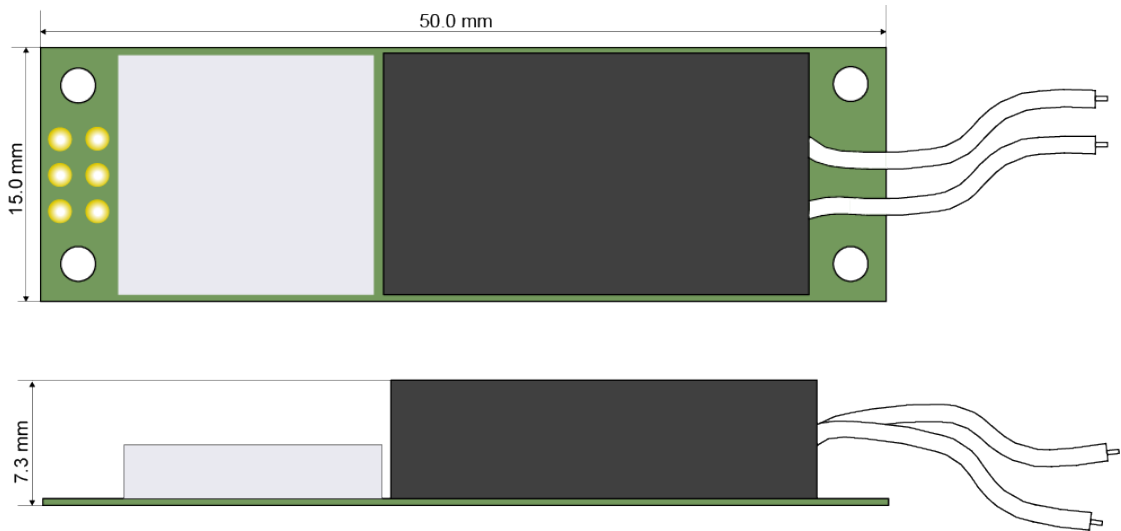

(Ultra Miniature Pockels Cell Driver)

3.0 OPERATION

3.1 PRECAUTION

Never disturb the signal:

Input signal to the driver is generated in the PC-Board. This signal is a high speed, noise sensitive signal. If it is disturbed by an accidental touch by a metal parts, or tools, internal components of the driver may be destroyed by an electro static noise.

3.2 WITH USING INTERNAL CLOCK

- STEP 1. CONNECT AC POWER CORD
Make sure On/Off SW. is still Off position.
- STEP 2. CONNECT 50OHM BNC CABLE for WAVEFORM.
Connect one end of the cable to an oscilloscope.
Make sure the input is set for 50 ohm.
- STEP 3. TURN VOLTAGE ADJ. TO MINIMUM.
Make sure the output voltage is set for zero, or minimum.
- STEP 4. TURN INT/EXT SWITCH TO INTERNAL
- STEP 5. TURN ON AC POWER
- STEP 6. INCREASE THE VOLTAGE ADJ.
Watching the output current waveform with the oscilloscope, gradually increase the voltage adj.
- STEP 7. ADJUST FREQUENCY
Set the pulse rep. rate for a desirable rate.

3.3 WITH USING EXTERNAL CLOCK

- STEP 1. CONNECT AC POWER CORD
Make sure On/Off SW. is still Off position.
- STEP 2. CONNECT 50OHM BNC CABLE for WAVEFORM.
Connect one end of the cable to an oscilloscope.
Make sure the input is set for 50 ohm.

- STEP 3. TURN VOLTAGE ADJ. TO MINIMUM.
 Make sure the output voltage is set for zero, or
 minimum.
- STEP 4. CONNECT 50OHM BNC CABLE for EXTERNAL SIGNAL
 Connect one end of the cable to a pulse generator.
- Note:*
*Make sure the external pulse rate is within the specification designed for the driver. If the
setting is exceeded to this range, the driver may be destroyed because of over heating.*
- STEP 5. TURN INT/EXT SWITCH TO EXTERNAL
- STEP 6. TURN ON AC POWER
- STEP 7. INCREASE THE VOLTAGE ADJ.
 Watching the output current waveform with the
 oscilloscope, gradually increase the voltage adj.
- STEP 8. ADJUST FREQUENCY
 Set the pulse rep. rate of the generator for a
 desirable rate.

4.0 MAINTENANCE

4.1 GENERAL

Lic's laser power supply contains potentiometers that are set at Lic's factory. Do not try to adjust these potentiometers. **There are no user-serviceable parts in Lic's products.**

IF USER ATTEMPTS TO OPEN, ADJUST, MODIFY, OR REPAIR THE PRODUCTS, THEN LIC ENGINEERING CAN NO LONGER BE RESPONSIBLE FOR THE SAFE OPERATION OF THE UNIT, AND THE WARRANTY SHALL BE IMMEDIATELY VOID.

4.2 CAUTION

- 1). DO NOT ALLOW THE UNIT TO BE IN OPEN CIRCUIT.
- 2). DO NOT ALLOW THE UNIT TO BE SHORT CIRCUIT.
- 3). DO NOT ATTEMPT TO OPEN, MODIFY OR ADJUST ANY PARTS OF THE POWER SUPPLY.
- 4). DO NOT MECHANICALLY SHOCK.
- 5). KEEP WATER OR MOISTURE OUT FROM THE UNIT EXCEPT IN/-
OUTLET
OF THE UNIT.
- 6). DO NOT MISUSE, OVERUSE, OR ABUSE THE UNIT.

5.0 **WARRANTY**

5.1 **WARRANTY**

Lic engineering warrants its products against all defects in materials and workmanship to the original using purchaser for a period of one year from the date of delivery to the original purchaser.

During this period, Lic engineering will repair or replace its products if defective free of charge. This warranty applies only when the products are properly installed, maintained and used for the intended purpose, and only to the original purchase/user of the products, and only so long as the products are used in the country to which it was originally shipped by Lic engineering, or by an authorized distributor.

Any shipping charge incurred shall be paid by the purchaser/user of the products.

This warranty is null and void if the user attempts to service the products (other than performing the maintenance described in the Instruction Manual), or if service is performed by people who are not trained and authorized to do so by Lic engineering.

THE EXPRESS WARRANTY ABOVE IS THE SOLE WARRANTY OBLIGATION OF LIC ENGINEERING AND THE REMEDY PROVIDED ABOVE IS IN LIEU OF GUARANTEES, OR WARRANTIES--ORAL OR WRITTEN, EXPRESS OR IMPLIED-- INCLUDING WITHOUT LIMITATION WARRANTY OR MERCHANTABILITY OR FITNESS FOR A PARTICULAR PURPOSE.

LIC ENGINEERING HAS NO LIABILITY WHATSOEVER FOR ANY INCIDENTAL OR CONSEQUENTIAL DAMAGE ARISING OUT OF ANY DEFECT, IMPROPER USE, OR UNAUTHORIZED SERVICE OR REPAIR.

5.2 **RETURN OF THE UNITS**

Prior to return of a unit, or any portion thereof, Lic must be consulted to avoid unnecessary shipping.

If returns of the units are deemed necessary, a Return Authorization Number "RAN" will be assigned. This number must be recorded on the outside of the shipping container.

Contact:

LIC Engineering
122 Calistoga Rd. Suite 210
Santa Rosa, CA 95409 USA
Tel: (707) 327-2705
email: info@LicEngine.com